



S I N T E R E D F I L T E R S

Published by:

Technische Handelsonderneming Nederland B.V. (THN)

Office address:

Hendrik ter Kuilestraat 30
7547 BD Enschede, the Netherlands

Contact:

Tel.: +31 (0)53 432 34 46
Fax: +31 (0)53 430 71 58

Email: info@thn.nl

Website: www.thn.nl

Version 1.0



Copyright © THN — All rights reserved

THN has compiled this brochure with great care. At the time of going to press, all data included in this brochure is up to date for the latest range of products. All information and all technical specifications have also been checked carefully. However, in the event of any advertent errors or omissions with regard to qualities, capacities, types or otherwise, THN cannot be held liable in any way.

No part of this publication may be reproduced, stored in an automated data file or made public in any form or by any means, whether electronic, mechanical or by photocopying, recording or any other method, without the prior written permission of the publisher. Reproduction of this brochure without the written permission of the publisher is also not permitted.

THN specializes in technical products which we can deliver rapidly with smart stocks and efficient logistics. Our aim is to score 100% customer satisfaction at all times, and we're improving all the time as we work hard day after day. We can also build on the more than 75 years of experience which THN has accumulated, and on our three pillars: commitment, innovation and delivery.

For THN it's all about the customer. That is because we get involved, helping each other as colleagues and as a team for our customers. For when developments need change, we will innovate. To serve you - the customer - even better. And so we can deliver what you need.

You will find everything about our range of sintered filters in this brochure. THN has a lot of experience with sintered filters and often supplies them as custom products to exact client specifications. We do this in close cooperation with the client.

As well as customized filters, THN always has large stocks of standard sintered silencers, also referred as PUKS.

As you can see. At THN, you've come to the right place for sintered filters. You can be assured of sourcing the very best sintered filters on the market and of super-fast delivery too.

1940

THN is established as a technical wholesaler



1970

THN specializes in piston rings



1974

THN adds plain bearings to its range



2007

THN adds linear components to its range



2015

THN celebrates its 75th anniversary

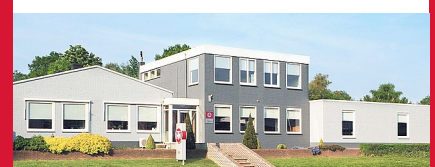

CONTENTS



SINTERED FILTERS

05



Puks ZBN

11



Puks ZBL

11



Puks ZBV

12



Puks ZBR

12



Puks ZRN

13



Puks VBN

13



Puks SBN

14



Puks SBK

14

MATERIALS

07

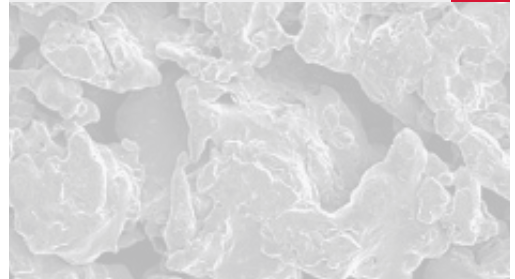

TECHNICAL CHARACTERISTICS

09

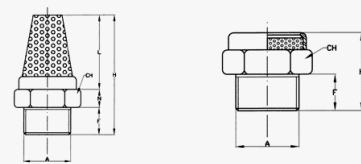

CUSTOMIZED

15



THN ensures its product offering is always up-to-date by training a keen eye on the market. For as well as sintered filters, THN also has a wide range of piston rings, Fey laminar rings, sintered filters and linear components.

How can we assist you with our other products?



PISTON RINGS



- diameters from 10 mm - 3000 mm
- available in many different materials
- bespoke possibilities

FEY LAMINAR RINGS



- high-quality steel seals
- internal/external clamping or combined
- types available up to +700 °C

PLAIN BEARINGS



- 1 million plain bearings in stock
- over 6,500 sizes and models
- custom plain bearings also available

LINEAR COMPONENTS



- hardened ground shafts
- support rails
- linear ball bearings and bearing housings

SINTERED FILTERS

GENERAL

Sintered filters are being used in an increasing number of applications. These filters are made from bronze, stainless steel or polyethylene. Sintered filters are characterized by close tolerances, a good price/quality ratio and a broad filter range of 0.5 to 200µm for SS and 8 to 100µm for bronze.

THN can supply a wide standard range of sintered filters, also known as PUKS.

As well as its standard range, THN can also supply many customized sintered filters. We design and develop these together with our customers so we can supply sintered filters that match their exact specifications.

CHARACTERISTICS

The main characteristics of sintered filters are:

- High temperature resistance
- Thermal stability
- Good resistance to corrosion
- High mechanical strength
- Flexible design
- Self-supporting molded sections suitable for high pressure differentials

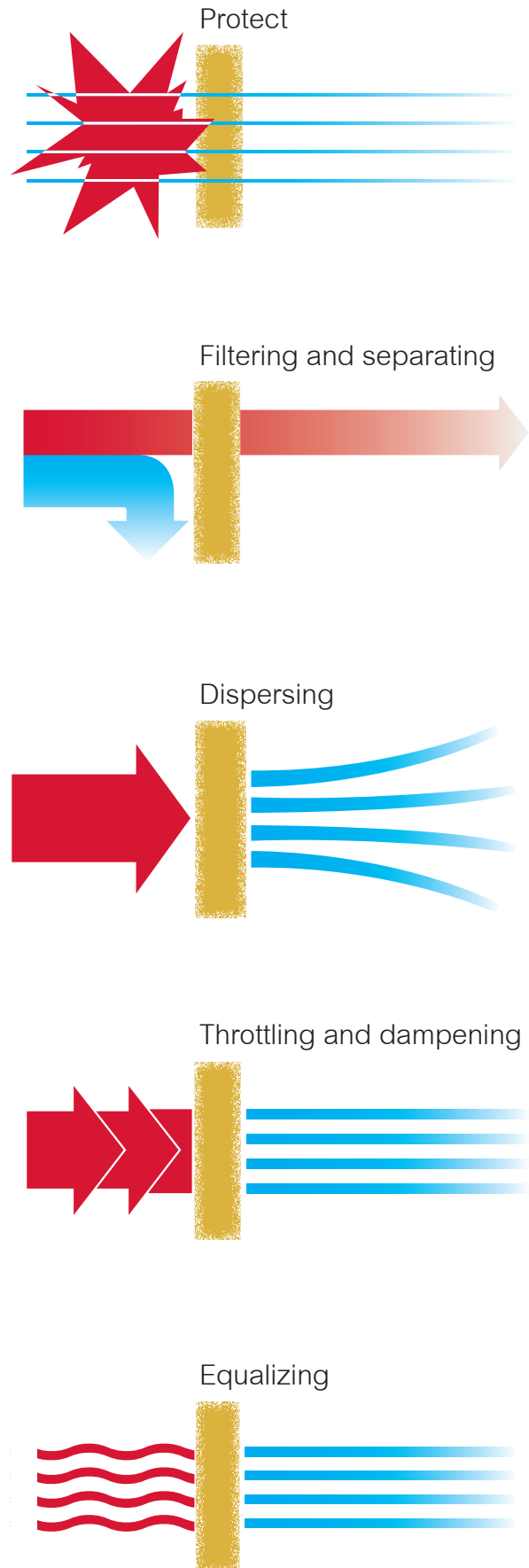

MATERIAL PROPERTIES AND PRODUCTION

BRONZE SINTERED FILTERS

Bronze sintered filters are made from spherical bronze powder. The form, size and distribution of the powder are important parameters which affect the filter's properties.

Bronze sintered filters are produced using the gravity sintering method. The bronze powder is placed in a mold and sintered.

During sintering, the powder particles are fused to one another at temperatures well below the melting point of the material. This process gives the highly porous filters their characteristic shape and properties.

After sintering, the size and position of the pores are mechanically fixed. The powder particles also form a rigid whole. This gives the filters a strength, form and stability equal to those of a bronze component.

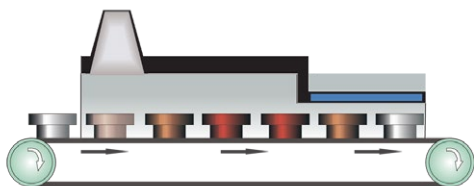

SS SINTERED FILTERS

SS sintered filters are made from any metallurgical material that is produced as a powder. The filter's ultimate properties are influenced by the shape, size and distribution of the powder.

The most common materials are highly alloyed SS types, but there are also nickel-based SS varieties and titanium.

During the production of SS sintered filters, the powder is compressed into a mold to create a solid, brittle component. The pore size can be determined by the powder that is chosen and the pressing force that is applied.

During sintering, the powder particles are fused to one another at temperatures well below the melting point of the material. This process gives the highly porous filters their characteristic shape and properties.

After sintering, the size and position of the pores are mechanically fixed. The powder particles also form a rigid whole. This gives the filters a strength, form and stability equal to those of a metal component.

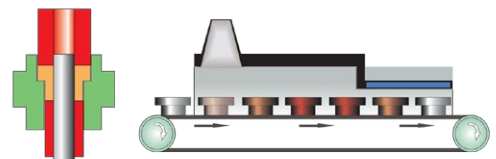

MATERIALS

SIKA-B

SIKA-B are sintered porous bronze parts produced from spherical bronze powder.

These items are highly corrosion resistant, are characterized by a high structural stability and strength, they are self-supporting and suitable for high pressure differentials.

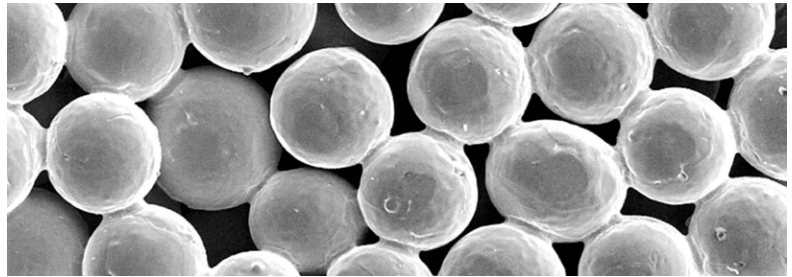

SIKA-R

SIKA-R are sintered porous SS parts produced from irregularly shaped SS powder, generally AISI 316L.

They are stronger than bronze filters because of the powder's irregular shape. They are also suitable for higher temperatures.

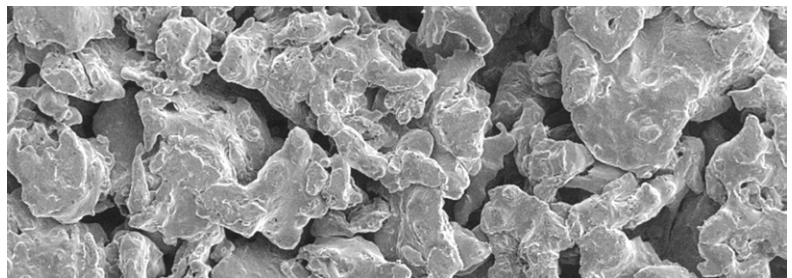

MATERIAL SPECIFICATIONS

Group	Material	W. no.	Max. temp		Key words
			Reduce	Oxidize	
Bronze	CuSn12	2.1052	300	250	For hydraulics and pneumatics
High-alloyed materials	AISI 304L	1.4306	540	400	(The) standard for applications in the food industry
	AISI 316L	1.4404	540	400	
	AISI 904L	1.4539	600	500	Resistant to sulphuric, phosphoric and hydrochloric acid
	AISI 310	1.4841	800	600	Heat-resistant
	FeCrAl	1.4767	900	900	
Nickel alloys	Hastelloy C 22	2.4602	650	650	Resistant to corrosion from different aggressive media. Sustained temperatures of >400 are possible.
	Hastelloy C 276	2.4819	650	600	
	Hastelloy X	2.4665	925	925	
	Inconel 600	2.4816	650	650	
	Inconel 625	2.4856	650	600	
	Monel 400	2.4360	500	500	
Titanium	Ti	-	500	500	Medicines, acids, electrolysis

TECHNICAL CHARACTERISTICS

SIKA-B

Bronze

Filter type	Permeability coefficient		Grade efficiency	Bubble-point pressure	Shear strength	
	α [10 - 12 m ²]	β [10 - 7 m]	x (T = 98% absolute) [μ m]	Δp [mbar]	τ [Nmm ²]	
SIKA-B	8	2	52	15	35	130
SIKA-B	12	6	64	27	23	120
SIKA-B	20	10	83	38	15	110
SIKA-B	30	14	89	52	13	100
SIKA-B	45	43	144	80	7.8	90
SIKA-B	60	50	202	100	7.0	90
SIKA-B	80	114	282	135	4.3	80
SIKA-B	100	127	406	183	3.7	70
SIKA-B	120	230	633	231	2.9	60
SIKA-B	150	248	643	260	2.5	40
SIKA-B	200	463	1046	320	1.5	30

SIKA-R

SS							
Filter type		Permeability coefficient		Grade efficiency	Bubble-point pressure	Shear strength	
		α [10 - 12 m ²]	β [10 - 7 m]	x (T = 98% absolute) [μ m]	Δp [mbar]	τ [Nmm ²]	
SIKA-R	0.5	0.08	0.3	1.3	89	350	
SIKA-R	1	0.13	0.6	1.9	85	355	
SIKA-R	3	0.4	1.7	3.3	59	311	
SIKA-R	5	0.8	2.0	6.8	40	278	
SIKA-R	7	2.5	15	7.8	25	200	
SIKA-R	10	3.9	24	9.0	23	160	
SIKA-R	15	5.6	13	20	16	200	
SIKA-R	20	8.3	22	26	15	138	
SIKA-R	30	13	18	32	11	144	
SIKA-R	40	27	37	40	9.0	135	
SIKA-R	50	36	36	44	6.0	121	
SIKA-R	80	52	48	52	5.0	98	
SIKA-R	100	65	58	65	4.5	85	
SIKA-R	150	117	53	110	3.5	110	
SIKA-R	200	150	69	130	3.0	95	

PUKS

SINTERED SILENCERS

PUKS, sintered silencers with a thread connection, are available in bronze and SS versions. THN has a standard range of products which are normally available from stock.

ZBN

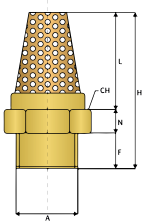

A	N	F	L	H	CH
BSP 1/8"	4	6	17	27	13
BSP 1/4"	5	8	19	32	16
BSP 3/8"	5	8	27	40	19
BSP 1/2"	5	10	32	47	24
BSP 3/4"	5	10	38	53	30
BSP 1"	6	10	49	65	36
M5	3	4	11	18	8

ZBL

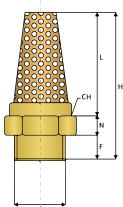

A	N	F	L	H	CH
BSP 1/8"	4	6	32	42	13
BSP 1/4"	5	7	35	47	16
BSP 3/8"	5	8	39	52	19
BSP 1/2"	5	10	52	67	24
BSP 3/4"	5	10	59	74	30
BSP 1"	6	10	73	89	36
M5	4	4	18	26	8

ZBV

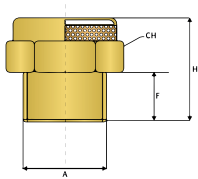

A	F	H	CH
BSP 1/8"	6	13	13
BSP 1/4"	7	16	16
BSP 3/8"	8	16	19
BSP 1/2"	10	18	24
BSP 3/4"	10	19	30
BSP 1"	10	20	36
M5	5	12	8

ZBR

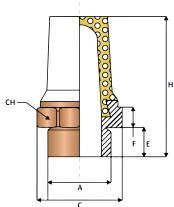

A	E	F	H	C	CH
BSP 1/8"	4.5	3.8	20.5	12.6	12
BSP 1/4"	6	4.5	26.5	16	15
BSP 3/8"	7	5.4	33.9	20	19
BSP 1/2"	8	6	40.5	24.5	23
BSP 3/4"	9	7.5	51.5	32	30
BSP 1"	11	9	66	38.5	36
M5	5.5	3.5	17	8	7

ZRN

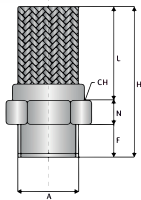

	A	N	F	L	H	CH
BSP 1/8"		5	6	16	27	13
BSP 1/4"		5	8	20	33	16
BSP 3/8"		5	8	27	40	19
BSP 1/2"		5	10	30	45	24

VBN

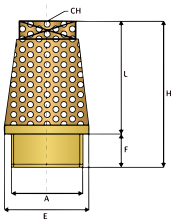

	A	E	F	L	H	CH
BSP 1/8"		12	6	15	21	7
BSP 1/4"		15	8	19	27	8
BSP 3/8"		19	8	28	38	10
BSP 1/2"		23	10	33	43	14
BSP 3/4"		30	13	40	53	17
BSP 1"		36	15	48	63	23

SBN

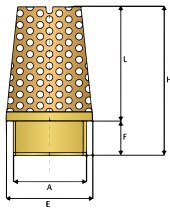

	A	E	F	L	H
BSP 1/8"		12	6	15	21
BSP 1/4"		15	7	19	26
BSP 3/8"		19	8	28	36
BSP 1/2"		23	10	33	43
BSP 3/4"		30	13	40	53
BSP 1"		38	15	48	63

SBK

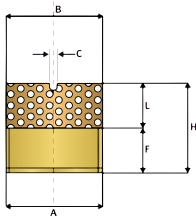

	A	B	F	L	H	C
BSP 1/8"		10	6	6	12	1.5
BSP 1/4"		13	8	6	14	1.5
BSP 3/8"		17	8	8	16	1.5
BSP 1/2"		20	12	8	20	2.5
BSP 3/4"		26	14	9	23	2.5
BSP 1"		33	14	11	25	2.5

CUSTOMIZED

CUSTOM SINTERED FILTERS

The growing demand for custom sintered filters means that a major proportion of the sintered filters which we supply are customized.

We work closely with our customers to design and develop sintered filters that meet their exacting specifications.

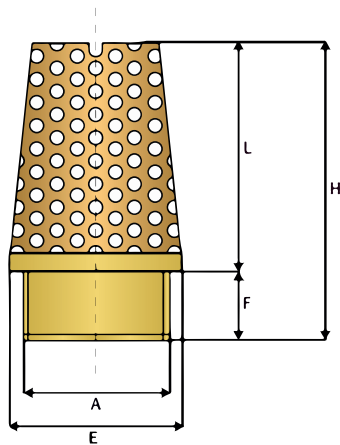

PROCESS

- 1. Application:** The first phase of the process is to decide what the product will be used for, what function the filter must perform and what technical characteristics are needed.
- 2. Design:** Depending on the data gathered during the first phase, the product's feasibility is investigated and a technical drawing is produced.
- 3. Production:** Once the customer has approved the drawing, the next step will usually be to start with a test series. If the test series looks like meeting all of the customer's wishes and requirements, then we switch to serial production.

FROM DRAWING TO SINTERED FILTER

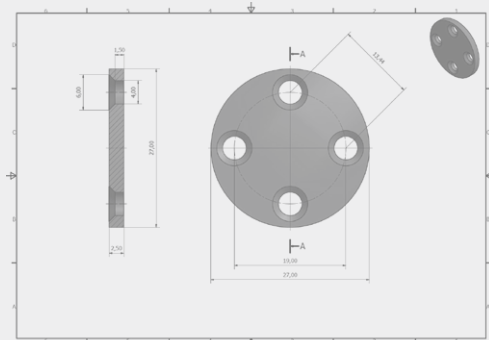

NOTES

TERMS AND CONDITIONS

GENERAL TERMS AND CONDITIONS OF SALE FOR TECHNISCHE HANDELSONDERNEMING NEDERLAND B.V.

Article 1 Definitions

In these terms and conditions, the terms below have the following meanings, unless specifically stated otherwise:

THN : Technische Handelsonderneming Nederland B.V.;
Buyer : the other party;
Agreement : the agreement between THN and the Buyer;

Article 2 General

2.1 The provisions of these terms and conditions apply to all offers, quotations, agreements and any other legal relationship between THN and the Buyer, insofar as the parties have not agreed to deviate from these terms and conditions explicitly and in writing;
2.2 These terms and conditions also apply to all agreements between THN and the Buyer for the execution of which THN uses the services of third parties;
2.3 These terms and conditions shall always replace those of the Buyer, unless the parties have agreed otherwise in writing;
2.4 If THN and the Buyer enter into more than one agreement, these terms and conditions apply to all subsequent agreements, regardless of whether these have been explicitly declared applicable in writing;
2.5 If one or more of the provisions of these terms and conditions are invalid or should become invalid, the remaining provisions of these terms and conditions will remain in force.

Article 3 Offers, quotations and agreements

3.1 All offers made by THN in any form are without obligation, unless the offer specifies a time scale for acceptance;
3.2 Agreements to which THN is party will only become enforceable:
a) after an agreement drawn up for that purpose has been signed by both parties, or;
b) after receipt of and agreement with the Buyer's written acceptance of an offer made by THN, or;
c) by the actual execution of work or delivery of goods by THN;
3.3 In cases of verbal agreement, the invoice will be deemed to correctly and fully represent the Agreement, unless it is disputed within 14 days of the date of the invoice;
3.4 If a natural person enters into an Agreement on behalf or on account of another natural or legal person, he or she declares to have the authority to do so by signing the Agreement. Any such person, as well as the other natural or legal person, will be held personally liable for any obligations pursuant to the Agreement;
3.5 Prices in the aforementioned offers and quotations are in Euro, and exclusive of VAT and other taxes, as well as of any transportation and packaging costs, unless explicitly stated otherwise;
3.6 If acceptance deviates from the offer stated in a quotation, THN will not be bound by it. The Agreement will not be executed in accordance with any deviations in acceptance, unless THN indicates otherwise;
3.7 The provision of a compound quotation does not oblige THN to fulfil any part of the obligations included in the offer or quotation against a proportion of the price quoted;
3.8 Offers or quotations do not apply to any subsequent orders;
3.9 If a quotation is not accepted, THN has the right to demand fair reimbursement by the party requesting the quotation for any costs related to the production of the quotation.

Article 4 Execution of the Agreement

4.1 THN cannot be held liable for damage of any kind caused by incorrect or incomplete information provided by the Buyer, unless the error or omission should have been recognised by THN;
4.2 THN has the right to deliver quantities that deviate within a margin of 5% either way from the quantities agreed between THN and the Buyer.

Article 5 Supply and completion

5.1 The Buyer is obliged to accept goods and services produced under the Agreement at the moment these are supplied or the order is completed by THN, delivered to the Buyer, or at the moment these are made available to the Buyer pursuant to the Agreement;
5.2 If the Buyer refuses to accept or fails to provide information or instructions required for supply or completion, THN has the right to store the goods at the expense and risk of the Buyer;
5.3 If THN requires information from the Buyer with regard to the execution of the Agreement, the supply or completion term will only commence once this has been provided to THN by the Buyer;
5.4 If THN has set a time scale for supply or completion, it is only indicative. Any supply or completion time scale indicated shall in no case be considered binding. If any such time scale is exceeded, the Buyer must give written notice of default to THN;
5.5 THN has the right to supply or complete work partially, unless the Agreement states otherwise or where partial supply or completion is of no independent value. THN has the right to invoice separately for partial supply or completion.

Article 6 Inspection and defects

6.1 The Buyer must inspect the supplied goods or services at the moment of supply or completion. In doing so, the Buyer should inspect whether the quality and quantity of the goods or services supplied or completed comply with what has been agreed, or with the requirements expected in normal (trading) transactions;
6.2 THN should be notified in writing of any visible defects within 8 days of supply or completion. Invisible defects should be reported in writing within 8 days of discovery but no later than 3 months after supply or completion;
6.3 THN must be allowed to inspect any reported defects;
6.4 If timely notice of defects was given and the defects have been verified by THN, THN will repair the defects or shortcomings within a reasonable time scale, or replace the goods or services that have been supplied or completed. Nonetheless, the Buyer will remain obliged to pay for work carried out and goods delivered;
6.5 If timely notice of any defect was not given or if the Buyer has put to use the goods or services supplied or completed, these will be deemed to have been supplied or completed satisfactorily;
6.6 If the Buyer wishes to return defective goods, this may only be done with the prior written permission of THN and in the manner indicated by THN.

Article 7 Compensation, price and costs

7.1 THN has the right to demand a deposit amount of 10 to 50% of the agreed price before work is commenced;
7.2 If THN has agreed a fixed price with the Buyer, THN reserves the right to increase that price in the cases stated below;
7.3 THN has the right to pass on to the Buyer changes in costs relating to social contributions, turnover taxes, exchange rates, wages, raw materials, semi-products, packaging materials or other costs occurring after the Agreement was made.

Article 8 Changes to the Agreement

8.1 If during the execution of the Agreement it becomes apparent that in order to deliver satisfactory results it is necessary to change or supplement the work being carried out, the parties should amend the Agreement to that effect in a timely and mutually agreed manner;
8.2 If the parties change and/or supplement the Agreement, the time of completion may be affected. THN will notify the Buyer of this as soon as possible;
8.3 If changes and/or additions to the Agreement have financial and/or qualitative consequences, THN will notify the Buyer of this in advance;

Article 9 Payment

9.1 Payment must be made either in cash upon supply or completion, or within 30 days of the date of the invoice, in the manner indicated by THN and in the currency on the invoice. Disagreements about the amount of an invoice do not defer the Buyer's obligation to pay;
9.2 If the Buyer fails to pay within the 30-day term, he or she is considered to be in default in the eyes of the law. The Buyer shall then owe interest of 1% per month or part thereof, unless the statutory interest or the statutory commercial interest (after 30 days) is higher, in which case the higher interest applies. The interest on the outstanding amount will be calculated from the moment the Buyer enters default until the moment the full amount has been received;
9.3 If the Buyer enters into liquidation, petitions for or enters into bankruptcy, requests or is granted debt rescheduling under the Dutch Natural Persons Debt Rescheduling Act, is repossessed or is granted (temporary) suspension of payment, the outstanding sums the Buyer owes THN will become due immediately;

Article 10 Retention of title

10.1 All materials and other goods delivered by THN will remain the property of THN until the Buyer has met all obligations towards THN;
10.2 The Buyer has no authority to sell, provide as security or otherwise encumber goods falling under retention of title rights;
10.3 With immediate effect, the Buyer gives unconditional and irrevocable permission for THN or any third parties it appoints to enter any premises that contain THN's property and to repossess these goods, should THN wish to exercise its retention of title rights as defined in this article.

Article 11 Transfer of risk

11.1 The risk of loss of or damage to goods produced by THN will be transferred to the Buyer from the moment these goods are legally or actually supplied or the order is completed, and thus brought into the ownership of the Buyer or a third party appointed by the Buyer.

Article 12 Collection costs

12.1 If the Buyer defaults on or neglects to fulfil his obligations (in a timely manner), the Buyer will be liable for all reasonable costs incurred in extrajudicial enforcement. In any case, the Buyer must pay collection costs if a monetary demand is made. Collection costs will be calculated in accordance with the collection cost rate recommended for collection cases by the Netherlands Bar, with a minimum cost of EUR 350.
12.2 If THN has incurred higher costs, and these were necessary and reasonable, the Buyer will also be liable for these costs. Any reasonable legal and execution costs incurred will also be charged to the Buyer.

Article 13 Suspension and dissolution

13.1 In addition to the provisions of the law, THN has the authority to defer the fulfilment of its obligations or dissolve the Agreement if it becomes apparent to THN after the Agreement has been made that there are circumstances as a consequence of which THN has good reason to expect that the Buyer will not fulfil, or only partially fulfil his or her obligations, or not fulfil them in a timely manner. If there is good reason to expect that the Buyer will only partially or not satisfactorily fulfil his or her obligations, the dissolution of the Agreement is only permitted if justified by the shortcoming, or if the Buyer was asked to guarantee the fulfilment of his or her obligations at the time the Agreement was made, and this guarantee is not provided or is insufficient.
13.2 In addition, THN has the authority to dissolve or cause the Agreement to be dissolved if circumstances are such that fulfilment of the Agreement is impossible or can reasonably and fairly be deemed to no longer be possible, or if other circumstances mean that fulfilment of the Agreement in its present form cannot reasonably be expected, without THN becoming liable for damages to the Buyer;
13.3 If the Agreement is dissolved, any sums owed to THN by the Buyer will become due immediately. If THN defers the fulfilment of its obligations, it will retain its rights under the law and the Agreement;
13.4 THN reserves the right to demand damage compensation in any case.

Article 14 Liability

14.1 If THN should incur any liability, it will be limited in accordance with the provisions of this article.
14.2 THN can only be held liable for wilful damage or damage resulting from neglect by THN or its subordinates.
14.3 If THN is held liable, liability will be limited to the maximum compensation amount due to be paid by THN's insurer, and liability shall not exceed the invoice amount for the (partial) work concerned.
14.4 THN will not in any case be held liable for damage caused by advice it provides. Any advice will be given based on the facts and circumstances known to THN and in mutual discussion with the Buyer, in which THN will take the Buyer's intentions as a guide and starting point.
14.5 THN will never be held liable for indirect damage, being consequential damage, lost profit, missed savings and damage from business stagnation.
14.6 THN must be notified immediately and in writing of any damage claims and in any case no later than within five working days of the damage occurring.

Article 15 Force majeure

15.1 THN is not bound to the fulfilment of any obligation if it is impeded from doing so by circumstances not caused wilfully or through neglect by THN and not attributable to THN either in the eyes of the law, through a legal exchange or by general accepted industry opinion;
15.2 In addition to the provisions of the law and the courts, in these general terms and conditions force majeure includes any expected or unexpected external causes which THN cannot influence, and which cause THN to be unable to fulfil its obligations. This includes labour strikes at THN, staff illness, theft, traffic delays, frost, rain and failure of suppliers to deliver materials;
15.3 THN also has the right to seek recourse to force majeure if the circumstances that impede (further) fulfilment occur after THN should have fulfilled its obligation;
15.4 THN can defer its obligations for the duration of the force majeure circumstances. If this period is longer than two months, THN has the right to dissolve the Agreement without incurring liability for damages to the Buyer;
15.5 If THN has partially fulfilled or will be able to partially fulfil its obligations under the Agreement at the time of the force majeure circumstances and the fulfilled part or part to be fulfilled respectively is deemed to have independent value, THN has the right to invoice separately for the fulfilled part or part to be fulfilled respectively. The Buyer must pay this invoice as if it were a separate Agreement.

Article 16 Disputes

16.1 The court of law in THN's locality has the exclusive jurisdiction to settle any disputes.

Article 17 Governing law

17.1 The laws of the Netherlands apply to any Agreement between THN and the Buyer..



THN

Hendrik ter Kuilestraat 30
7547 BD Enschede
the Netherlands

+31 (0)53 432 34 46

www.thn.nl