



PLAIN BEARINGS

Published by:

Technische Handelsonderneming Nederland B.V. (THN)

Office address:

Hendrik ter Kuilestraat 30  
7547 BD Enschede, the Netherlands

Contact:

Tel.: +31 (0)53 432 34 46  
Fax: +31 (0)53 430 71 58

Email: [info@thn.nl](mailto:info@thn.nl)

Website: [www.thn.nl](http://www.thn.nl)

Version 1.0



Copyright © THN — All rights reserved

THN has compiled this brochure with great care. At the time of going to press, all data included in this brochure is up to date for the latest range of products. All information and all technical specifications have also been checked carefully. However, in the event of any advertent errors or omissions with regard to qualities, capacities, types or otherwise, THN cannot be held liable in any way.

No part of this publication may be reproduced, stored in an automated data file or made public in any form or by any means, whether electronic, mechanical or by photocopying, recording or any other method, without the prior written permission of the publisher. Reproduction of this brochure without the written permission of the publisher is also not permitted.

THN specializes in technical products which we can deliver rapidly with smart stocks and efficient logistics. Our aim is to score 100% customer satisfaction at all times, and we're improving all the time as we work hard day after day. We can also build on the more than 75 years of experience which THN has accumulated, and on our three pillars: commitment, innovation and delivery.

At THN, it's all about the customer. That is because we get involved, helping each other as colleagues and as a team for our customers. For when developments need change, we will innovate. To serve you - the customer - even better. And so we can deliver what you need.

You will find everything about our range of plain bearings in this brochure. The range comprises plain bearings, flanged bearings, strips and thrust washers with and without a flange. In addition to our broad range, we can nearly always supply plain bearings made from other materials in other dimensions, tolerances and designs.

With more than a million plain bearings in 6,500 sizes and designs, at THN, you've come to the right place. You can be assured of sourcing the very best plain bearings on the market and of super-fast delivery too.

1940

THN is established as a technical wholesaler



1970

THN specializes in piston rings



1974

THN adds plain bearings to its range



2007

THN adds linear components to its range



2015

THN celebrates its 75th anniversary



# CONTENTS



## PLAIN BEARING OVERVIEW

05

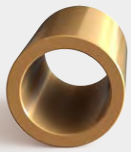

SINTERED BRONZE BEARINGS  
DIMENSION TABLES

07

25

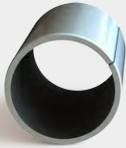

PTFE BEARINGS  
DIMENSION TABLES

09

33

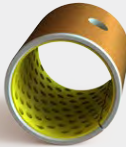

POM BEARINGS  
DIMENSION TABLES

11

39



WRAPPED BRONZE BEARINGS  
DIMENSION TABLES

13

41

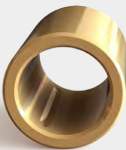

SOLID BRONZE BEARINGS  
DIMENSION TABLES

15

43



MAINTENANCE-FREE BEARINGS WITH  
LUBRICATING PLUGS  
DIMENSION TABLES

17

45

## OTHER BEARINGS

19

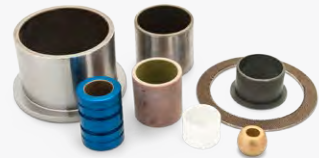

## TECHNICAL SPECIFICATIONS

21

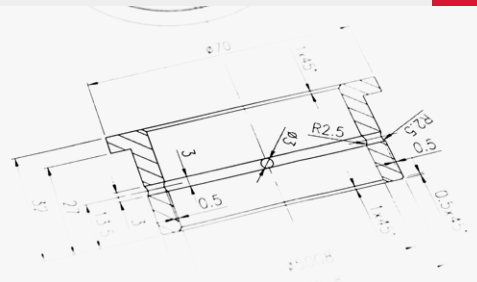

## INSTALLATION INSTRUCTIONS

23



THN ensures its product offering is always up-to-date by keeping a keen eye on the market. For as well as plain bearings, THN can also offer a wide range of piston rings, Fey laminar rings, sintered filters and linear components.

How can we assist you with our other products?



#### PISTON RINGS



- diameters from 10 mm - 3000 mm
- available in many different materials
- bespoke possibilities

#### FHEY LAMINAR RINGS



- high-quality steel seals
- internal/external clamping or combined
- types available up to +700 °C

#### SINTERED FILTERS



- sintered silencers
- a wide range of products in stainless steel and bronze
- bespoke sintered filters

#### LINEAR COMPONENTS



- hardened ground shafts
- shaft support rails
- linear ball bearings and bearing housings

# THN PLAIN BEARINGS OVERVIEW

	SINTERED BRONZE			PTFE		
	PLAIN BEARINGS			DRY BEARINGS		
	BRONZE	IRON	MoS <sup>2</sup>	STEEL	BRONZE	STAINLESS STEEL
Self-lubricating	②	②	②	③	③	③
Maintenance-free	②	②	②	③	③	③
Dirty environments	①	①	①	①	①	①
Corrosion-resistant	①	①	①	①	②	③
High temperature	①	①	③	③	③	③
High load	①	①	①	②	②	②
Shock loads/vibrations	①	①	①	①	①	①
High sliding velocity	③	③	①	②	②	②
Low friction	②	②	①	③	③	③
Poor shaft surface finish	①	①	①	①	①	①
Small operating clearance	①	①	①	③	③	③
Insensitive to misalignment	①	①	①	①	①	①

Standard range



① Unsuitable    ② Good    ③ Very good    ④ Excellent

POM  
PLAIN BEARINGS

WRAPPED  
BRONZE BEARINGS

TURNUED  
BRONZE BEARINGS

MAINTENANCE-FREE BEARINGS  
WITH LUBRICATING PLUGS

②

①

①

②

②

①

①

③

①

③

②

①

①

②

②

②

①

②

②

③

③

①

①

③

①

②

②

③

②

①

①

①

③

①

①

①

①

①

②

①

②

①

①

①

①

①

②

②



# SINTERED BRONZE BEARINGS

## HIGH SLIDING VELOCITIES AND MAINTENANCE FREE

Sintered bearings are characterized by being self-lubricating and maintenance-free. These bearings are made of porous bronze or iron and are usually filled with oil.

Their high permissible sliding velocities make these bearings ideally suited for rotating applications.

## ADVANTAGES

Main advantages of sintered bronze bearings include:

- Self-lubricating
- Maintenance-free
- High sliding velocities
- Low friction coefficient
- Low-noise running

## MATERIALS

Most of the sintered bronze bearings supplied by THN are made from SINT A51 or a comparable material, and are 18% - 20% impregnated with mineral oil.

THN can also supply sintered iron or bronze bearings with MoS<sub>2</sub>.

Always ask us for instructions when bearings are being machined. This is necessary because of pores clogging.

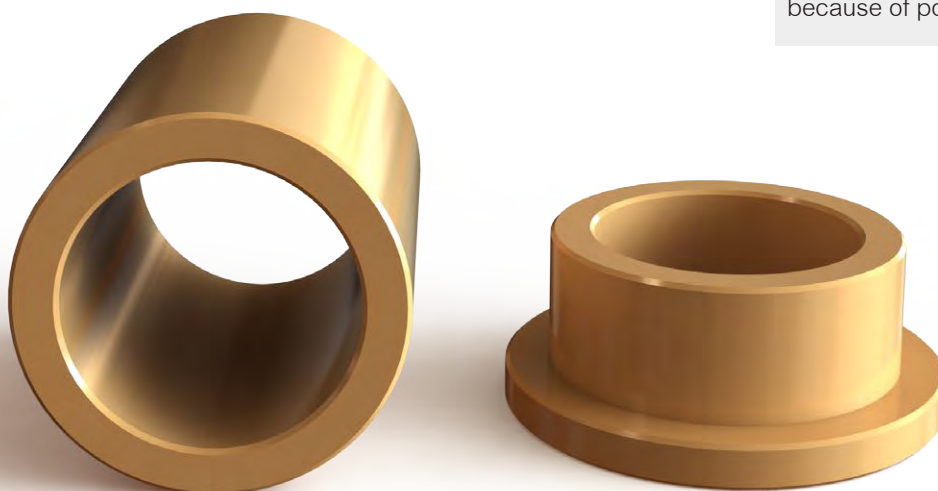

## PROPERTIES

	Sintered bronze	Sintered iron	MoS <sub>2</sub>
Max. load (Dyn/stat), N/mm <sup>2</sup>	10 / 50	9.5 / 50	2.5 / 50
Max. sliding speed m/s	5	5	0.25
Max. PV value N/mm <sup>2</sup> x m/s	1.6	1.6	0.4
Temperature range, °C	-10 / +90	-10 / +90	-50 / +300
Shaft tolerance	See table on page 8	See table on page 8	See table on page 8
Housing tolerance	H7	H7	H7
Shaft roughness	Ra < 0.8	Ra < 0.8	Ra < 0.8
Shaft hardness	HB > 220	HB > 220	HB > 220





## APPLICATIONS

Sintered bronze bearings are most suitable for rotary applications requiring self-lubricating operation.

Common applications are:

- Packaging machines
- Automotive
- Power tools
- Domestic appliances
- Starter motors
- Fans

## LUBRICATION

Most sintered bronze bearings are oil-filled. When storing and installing these bearings, they must not be allowed to come into contact with absorbent materials which could extract the oil from the bearings. Adding extra lubrication is not necessary under normal circumstances.

## TOLERANCE TABLE FOR SINTERED BRONZE BEARINGS

Tolerance	d	D	L	D1	B	Ds	Dp	Di	Da
E7/r7	E7	r7	h13	js13	h13	H7	s5	F7	h8
E8/r8	E8	r8	h13	js13	h13	H7	s5	F7	h8
G7/s7	G7	s7	js13	-	-	H7	s5	H7	f7
G8/s8	G8	s8	js13	js13	js14	H8	s5	H8	f7
F7/s7	F7	s7	js13	-	-	H7	m6	H7	f7
F8/s8	F8	s8	js13	js13	js13	H8	m6	H8	f7

d = inside dimension | D = outside dimension | L = length | D1 = flange diameter | B = flange thickness | Ds = bearing housing | Dp = press arbor | Di = end tolerance | Da = shaft

# PTFE BEARINGS

## HIGH LOAD AND MAINTENANCE-FREE

PTFE bearings are ideal for applications with high loads and moderate speeds. They are characterized by being maintenance-free.

These bearings are produced according to ISO 3547.

## ADVANTAGES

Main advantages of PTFE bearings include:

- Self-lubricating
- Maintenance-free
- High load
- Low friction coefficient
- Minimal bearing play
- Operating temperature up to 250°C

## MATERIALS

PTFE bearings are made with a steel or bronze backing as standard. A stainless steel backing is available on request. A sintered bronze layer is applied to the backing. This layer is provided with a PTFE-based self-lubricating unleaded sliding surface.

The bronze intermediate layer ensures efficient heat dissipation and makes for a strong joint between the backing and the sliding surface. The steel backing has a layer of tin to prevent corrosion.

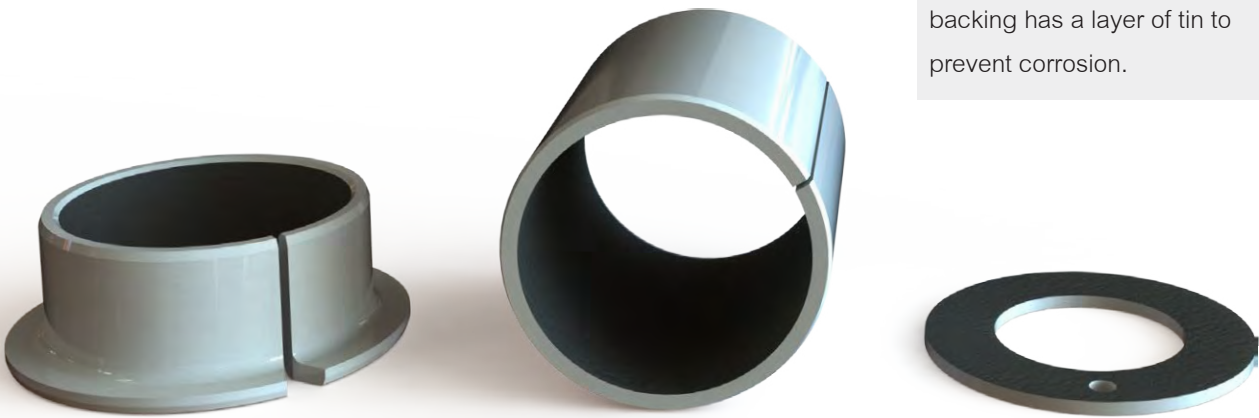

## PROPERTIES

	TU (Steel)	TU-B (Bronze)	TU-I (Stainless steel)
Max. load (Dyn/stat), N/mm <sup>2</sup>	140 / 250	140 / 140	140 / 250
Max. sliding speed m/s	2.5	2.5	2.5
Max. PV value N/mm <sup>2</sup> x m/s	1.8	1.8	1.8
Temperature range, °C	-200 / +280	-200 / +280	-200 / +280
Shaft tolerance	f7 - h8	f7 - h8	f7 - h8
Housing tolerance	H7	H7	H7
Shaft roughness	Ra ≤ 0.4	Ra ≤ 0.4	Ra ≤ 0.4
Shaft hardness	HB > 200	HB > 200	HB > 200



## APPLICATIONS

PTFE bearings are best suited to applications with high loads and requiring self-lubricating operation.

Common applications are:

- Elevators
- Hydraulics
- Textile machines
- Butterfly valves
- Consumer electronics

## LUBRICATION

During a short run-in period, part of the run-in layer, the PTFE mixture, is transferred to the counter-material. During this run-in period the bearing surface usually takes on a gray/green color. The characteristic low friction and wearing values are obtained at the end of the run-in period.

Adding oil or other non-corrosive fluids can enhance the bearing's performance.

## SECTIONAL VIEW OF PTFE BEARINGS

Tin layer  
Steel / Bronze / Stainless steel backing  
Sintered bronze layer  
PTFE

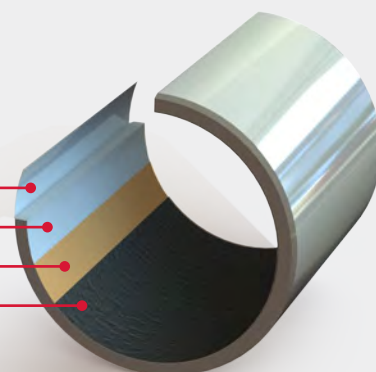

# POM BEARINGS

## MINIMAL MAINTENANCE

### UNDER SEVERE OPERATING CONDITIONS

POM bearings have been specially developed for marginally lubricated applications and so can function for long periods with minimal lubrication.

POM bearings are produced according to ISO 3547.

## ADVANTAGES

Main advantages of POM bearings include:

- Minimal maintenance
- High sliding velocity
- High load
- Low friction coefficient
- Minimal bearing play

## MATERIALS

POM bearings are made from a steel backing to which a sintered bronze layer is applied. A POM top layer is then applied to this bronze layer. The bronze intermediate layer ensures efficient heat dissipation and makes for a strong joint between the steel backing and the sliding surface.

The steel backing is provided with a layer of copper or tin to prevent corrosion, while the POM top layer incorporates grease pits to retain the lubricant.

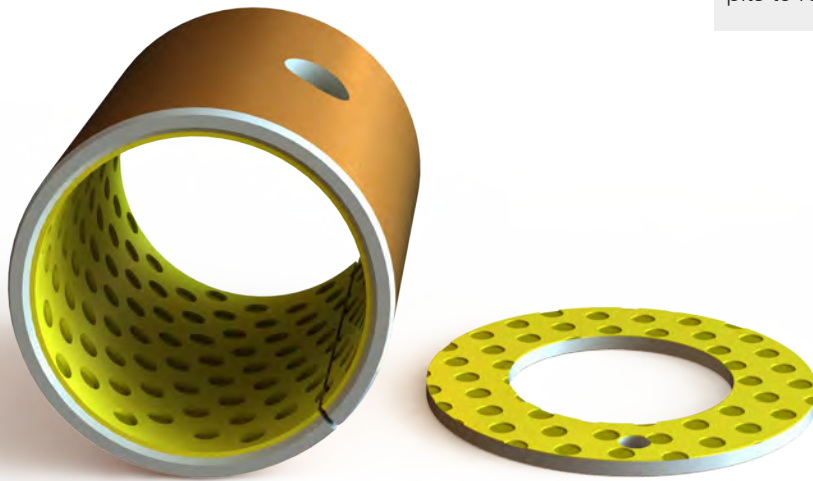

## PROPERTIES

	TX
Max. load (Dyn/stat), N/mm <sup>2</sup>	140 / 250
Max. sliding speed m/s	2.5
Max. PV value N/mm <sup>2</sup> x m/s	2.8
Temperature range, °C	-40 / +130
Shaft tolerance	f7 - h8
Housing tolerance	H7
Shaft roughness	Ra ≤ 0.4
Shaft hardness	> 200 HB



## APPLICATIONS

POM bearings are specially suited to severe operating conditions where frequent maintenance is not possible.

Common applications are:

- Hydraulic applications
- Elevators
- Transportation
- Mechanical engineering
- Construction machinery

## LUBRICATION

We recommend that POM bearings are lubricated with grease. The grease must contain an antioxidant for environments with temperatures over 50°C. Greases containing EP additives or significant amounts of graphite or MoS<sub>2</sub> are not generally recommended.

Lubricating with oil is only advisable with applications in which the oil temperature does not exceed 70°C.

## SECTIONAL VIEW OF POM BEARINGS

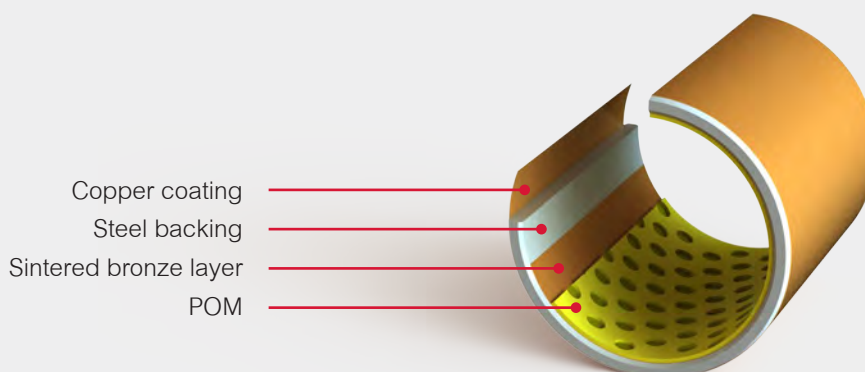

# WRAPPED BRONZE BEARINGS

## LONG SERVICE INTERVALS UNDER SEVERE OPERATING CONDITIONS

Wrapped bronze bearings are ideal for applications where there are high levels of pollution. Their sliding surface is indented with diamond-shaped pockets or holes for lubrication. The pockets must be filled with grease when the bearing is installed.

These bearings are produced according to ISO 3547.

## ADVANTAGES

Main advantages of wrapped bronze bearings include:

- Long service intervals
- Not affected by impurities
- Suitable for corrosive environments
- Suitable for impact loads and vibrations at low speeds
- Good heat dissipation

## MATERIALS

Wrapped bronze bearings are made entirely from phosphor bronze CuSn8. This material is characterized by the purity of the alloy with only a very low level of impurities.

These plain bearings are produced from strips which are subsequently wrapped and calibrated.

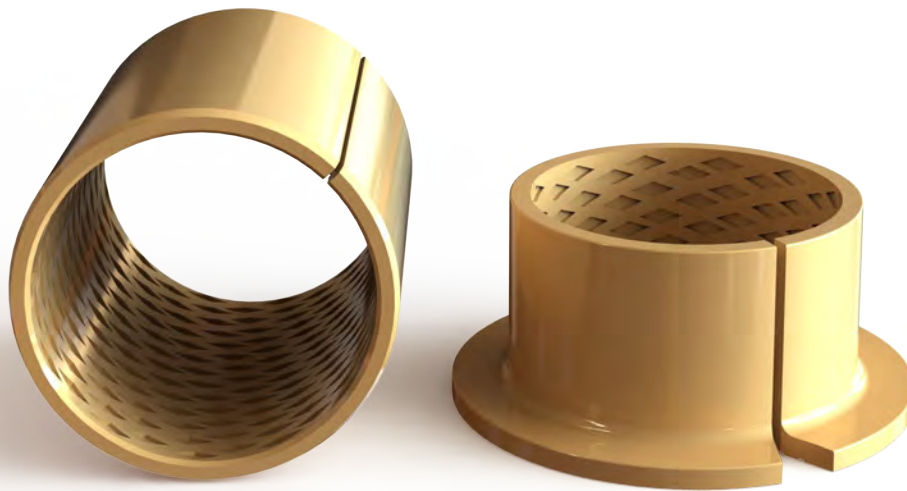

## PROPERTIES

	T90	T92
Max. load (Dyn/stat), N/mm <sup>2</sup>	40 / 120	40 / 120
Max. sliding speed m/s	2.0	2.5
Max. PV value N/mm <sup>2</sup> x m/s	2.8	2.8
Temperature range, °C	-100 / +200	-100 / +200
Shaft tolerance	e7 - f8 - h6	e7 - f8 - h6
Housing tolerance	H7	H7
Shaft roughness	Ra ≤ 0.8	Ra ≤ 0.8
Shaft hardness	> 200 HB	> 200 HB



## APPLICATIONS

Wrapped bronze bearings are specially suited to severe operating conditions where frequent maintenance is not possible.

Common applications are:

- Agricultural vehicles
- Lifting gear
- Offshore
- Excavators

## LUBRICATION

Wrapped bronze bearings must be lubricated with grease or oil on installation. A good quality lubricant is essential as it will reduce friction and wear by forming a film between the plain bearing and the shaft.

For heavily contaminated applications we recommend sealing off the bearing. This will protect both the bearing and the lubricant.

## DETAIL OVERVIEW OF LUBRICATION POCKETS

T90

Shaft diameter <22 mm

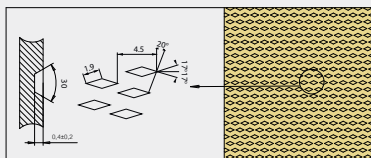

Shaft diameter >22 mm

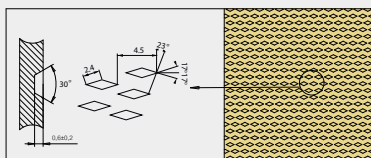

T92

Shaft diameter <25 mm

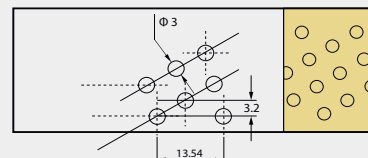

Shaft diameter >25 mm

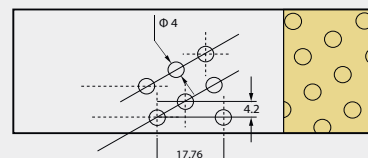

# SOLID BRONZE BEARINGS

## GOOD IN SEVERE AND CONTAMINATED CONDITIONS

Solid bronze bearings are highly suited to demanding applications in challenging environments. This makes them ideal for a wide variety of applications.

## ADVANTAGES

Main advantages of solid bronze bearings include:

- Not affected by impurities
- Suitable for corrosive environments
- Suitable for impact loads and vibrations at low speeds
- Has a groove to retain the lubricant

## MATERIALS

Solid bronze bearings are made from CuSn7Zn4Pb7 continuously cast bronze. This material is 85% copper and has very good sliding characteristics. All the surfaces of this plain bearing are machined.

Many other alloys are also available beside the standard material. Most common among these are CuAl10Ni, CuSn10 and CuSn12.

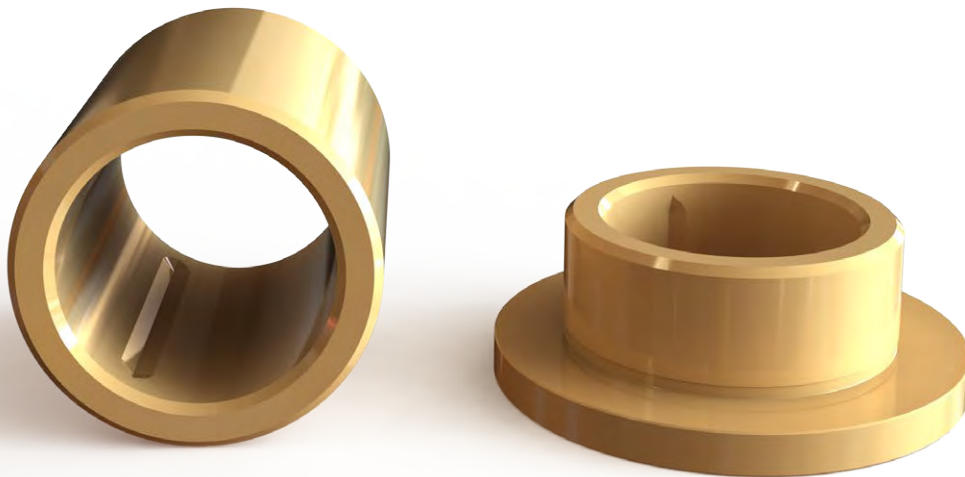

## PROPERTIES

	TB
Max. load (Dyn/stat), N/mm <sup>2</sup>	25 / 45
Max. sliding speed m/s	0.5
Max. PV value N/mm <sup>2</sup> x m/s	2.8
Temperature range, °C	+250 (depending on type of lubricant)
Shaft tolerance	e7 - e8
Housing tolerance	H7
Shaft roughness	Ra ≤ 1.0
Shaft hardness	> 165 HB





## APPLICATIONS

Solid bronze bearings are ideal for applications involving oscillatory movements, both axial and radial. They are also suitable for applications with slow rotational speeds.

Common applications are:

- Offshore
- Dredging industry
- Mechanical engineering
- Elevators

## LUBRICATION

Solid bronze bearings are normally lubricated with grease but oil is also used for exceptional applications. A good quality lubricant will ensure that friction and wear will be reduced by the forming of a film between the bearing and the shaft. For heavily contaminated applications we recommend sealing off the bearing. This will protect both the bearing and the lubricant.

All solid bronze bearings with an inside diameter of 14 mm or more are provided with an axial lubrication groove.

## LUBRICATION GROOVE OPTIONS

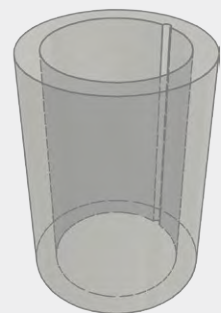
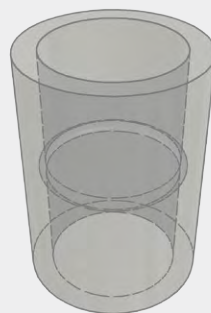
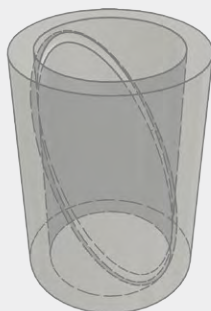
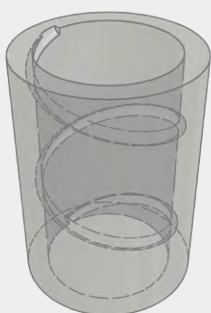

# MAINTENANCE-FREE BEARINGS WITH LUBRICATING PLUGS

## SELF-LUBRICATING

### MAINTENANCE-FREE BEARINGS FOR HEAVY DUTIES

Maintenance-free bearings with lubricating plugs are suitable for heavy loads, high temperatures, vibrations and for use in corrosive environments.

By using CuAl10Ni with special lubricating plugs, this plain bearing can also be used in applications with salt water.

## ADVANTAGES

Essential advantages of maintenance-free bearings with lubricating plugs are:

- Suitable for corrosive environments
- High load
- Maintenance-free
- Suitable for impact loads and vibrations
- Suitable for high temperatures

## MATERIALS

The maintenance-free bearings with lubricating plugs are made from CuZn25Al5 and have a pattern of lubricating plugs.

CuZn25Al5 is brass that has copper and zinc as its basis and is a construction material characterized by a high static load capability.

As well as CuZn25Al5 there are many other alloys suitable for both the bearing and the lubricating plugs.



## PROPERTIES

	TO
Max. load (Dyn/stat), N/mm <sup>2</sup>	100 / 250
Max. sliding speed m/s	0.25
Max. PV value N/mm <sup>2</sup> x m/s	3.34
Temperature range, °C	+300 (depending on material)
Shaft tolerance	e7 - f7 - h6
Housing tolerance	H7
Shaft roughness	Ra ≤ 1.0
Shaft hardness	> 200 HB



## APPLICATIONS

Maintenance-free bearings with lubricating plugs are most suitable for applications involving a high loading and requiring maintenance-free operation.

Common applications are:

- Flood/lock gates
- Offshore
- Iron and steel industry
- Furnace construction
- Mold construction

## LUBRICATION

Maintenance-free bearings with lubricating plugs are provided with fixed lubricating plugs as standard.

Additional lubrication is recommended for very low or very high speeds.

## DETAIL OF LUBRICATING PLUGS



# OTHER PLAIN BEARINGS

## OTHER PLAIN BEARINGS FOR A VARIETY OF CONDITIONS AND APPLICATIONS

These plain bearings are less common but are just as crucial for specific applications and are required to operate under changing conditions.

Whenever the standard range does not go far enough for applications in the food industry or which require precision bearings or which operate under very severe conditions, THN can always supply the right plain bearings.

## EXAMPLES

Here are some common examples of other plain bearings:

- Spherical and self-adjusting plain bearings
- Bearing blocks with or without bearing
- Plastic plain bearings
- Steel bearings
- Fiberglide bearings
- Wrapped plain bearings, internal clamping
- Woven plastic bearings
- High-grade bronze/aluminum alloys



# CUSTOM PLAIN BEARINGS

## BESPOKE PLAIN BEARINGS

There is a growing demand for plain bearings with non-standard specifications. THN always joins its customer in the search for a solution. That's why we can supply plain bearings in a wide variety of materials, sizes, tolerances and designs.

## SPECIAL MODELS

Some examples of special models of plain bearings are:

- Spherical plain bearings, self-adjusting if required
- Plain bearings with special grooves
- Plain bearings with recesses
- Plain bearings with non-standard tolerances

## MATERIALS

THN is supplying a growing number of clients with customized plain bearings made from materials such as sintered bronze BP 25, SINT A50, SINT A51, SINT B50, SINT B51, impregnated with MoS<sub>2</sub>, or just plain bearings with different alloys.







































# SPECIFICATION OVERVIEW

	SINTERED BRONZE			PTFE
	PLAIN BEARINGS			DRY BEARINGS
	BRONZE	IRON	MoS <sup>2</sup>	STEEL
Temperature range, °C	-10 / +90	-10 / +90	-50 / +300	-200 / +280
Coefficient of friction	0.05 - 0.10	0.05 - 0.10	0.15 - 0.25	0.03 - 0.25
Dynamic loading N/mm <sup>2</sup>	10	9.5	2.5	140
Static loading N/mm <sup>2</sup>	50	50	50	250
Max. speed m/s	5	5	0.25	2.5
Shaft tolerance	Table on page 8	Table on page 8	Table on page 8	f7 - h8
Housing tolerance	H7	H7	H7	H7
Shaft roughness Ra	< 0.8	< 0.8	< 0.8	Ra ≤ 0.4
Shaft hardness HB	≥ 220	≥ 220	≥ 220	> 200
Shaft hardness long service HB				
PV N/mm <sup>2</sup> x m/s	1.6	1.6	0.4	k <sup>1</sup> 3.5 / c <sup>2</sup> 1.8
Compressive strength N/mm <sup>2</sup>	100	150		350

Models



<sup>1</sup> Short    <sup>2</sup> Continuous    <sup>3</sup> Standard, but depending on material and lubricating plugs

PTFE		POM		WRAPPED		TURNED		MAINTENANCE-FREE
DRY BEARINGS		PLAIN BEARINGS		BRONZE BEARINGS		BRONZE BEARINGS		SLIDE BEARINGS WITH
BRONZE	STAINLESS STEEL							LUBRICATING PINS
-200 / +280	-200 / +280	-40 / +130	-40 / +130	-100 / +200	-100 / +200	-40 / +250	-40 / +250	+300 <sup>*3</sup>
0.03 - 0.25	0.03 - 0.25	0.05 - 0.20	0.05 - 0.20	0.08 - 0.25	0.08 - 0.25	0.08 - 0.15	0.08 - 0.15	0.03 - 0.16
140	140	140	140	40	40	25	25	100
140	250	250	250	120	120	45	45	250
2.5	2.5	2.5	2.5	2.5	2.5	0.5	0.5	0.25
f7 - h8	f7 - h8	f7 - h8	f7 - h8	e7 - f8 - h6	e7 - f8 - h6	e7 - f8	e7 - f8	e7 - f7 - h6
H7	H7	H7	H7	H7	H7	H7	H7	H7
Ra ≤ 0.4	Ra ≤ 0.4	≤ 0.4	≤ 0.4	≤ 0.8	≤ 0.8	≤ 1.0	≤ 1.0	≤ 1.0
> 200	> 200	> 200	> 200	> 200	> 200	> 165	> 165	> 200
		> 350	> 350	> 350	> 350	> 350	> 350	> 350
k <sup>*1</sup> 3.5 / c <sup>*2</sup> 1.8	k <sup>*1</sup> 3.5 / c <sup>*2</sup> 1.8	2.8	2.8	2.8	2.8	2.8	2.8	3.34
300	350	380	380	250	250	250	250	480
								
								
								
								

# INSTALLATION INSTRUCTIONS

## FITTING SINTERED AND SOLID BRONZE BEARINGS

The bearings are pressed into place with a press arbor. When the bearing is pressed in, the bore becomes smaller.

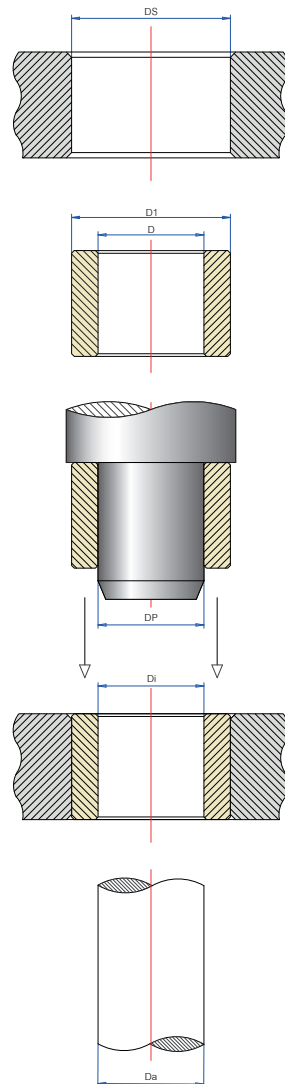

### PRESS ARBOR DATA AND BACKING DATA

Bearing	Housing phase	Press arbor diameter tolerance	Press arbor phase
Sintered bronze E7 and E8	1 mm x 45°	s6	3 mm x 15°
Sintered bronze G7 and G8	1 mm x 45°	n5	3 mm x 15°
Sintered bronze F7 and F8	1 mm x 45°	m6	3 mm x 15°
Solid bronze bearings	2 mm x 30°	c9	3 mm x 15°
Maintenance-free bearings	1 mm x 45°	c9	3 mm x 15°



# FITTING WRAPPED PLAIN BEARINGS

The bearings are pressed into place with a press arbor. When the bearing is pressed in, the bore becomes smaller.

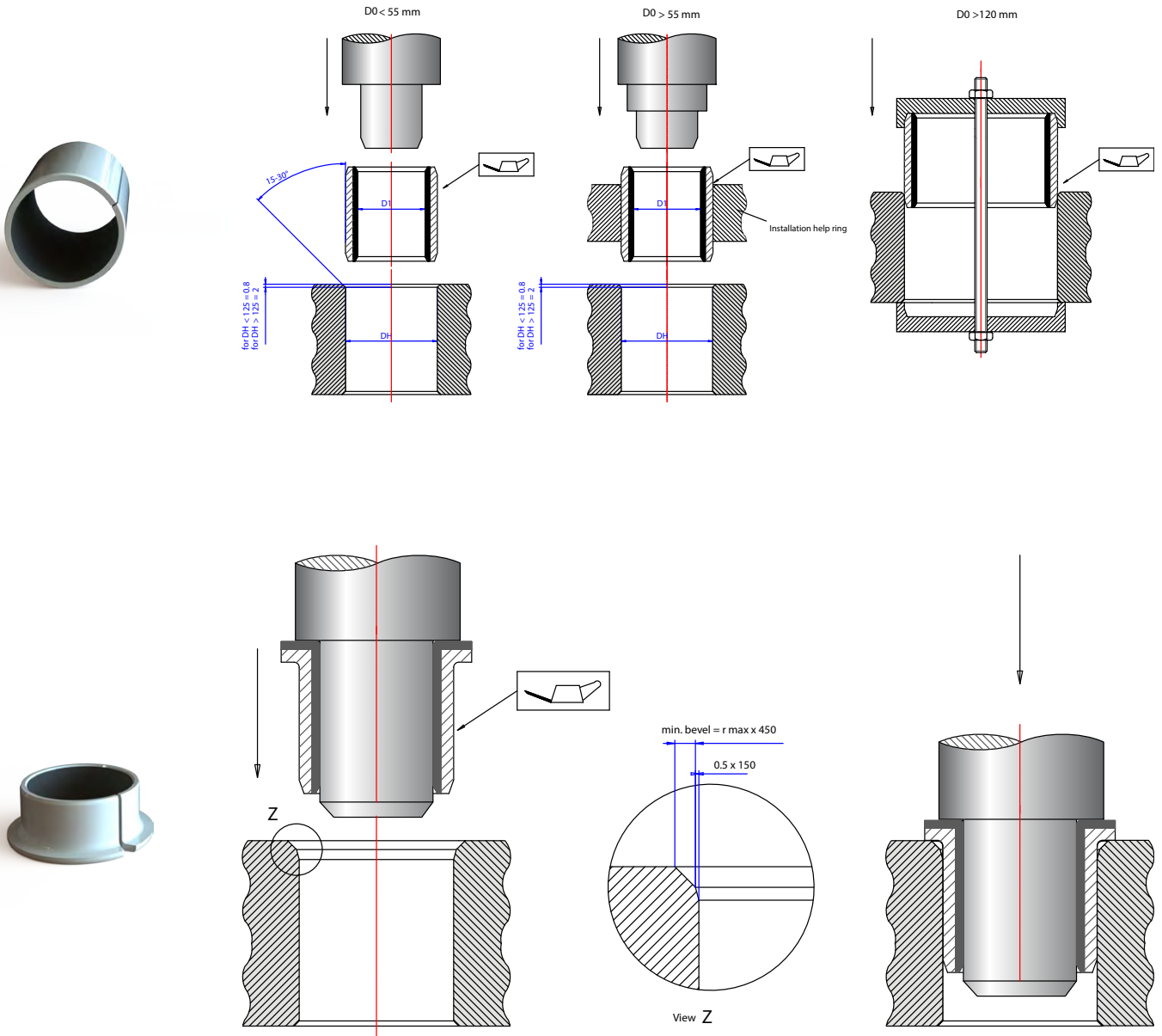

## MAXIMUM PRESSING FORCE

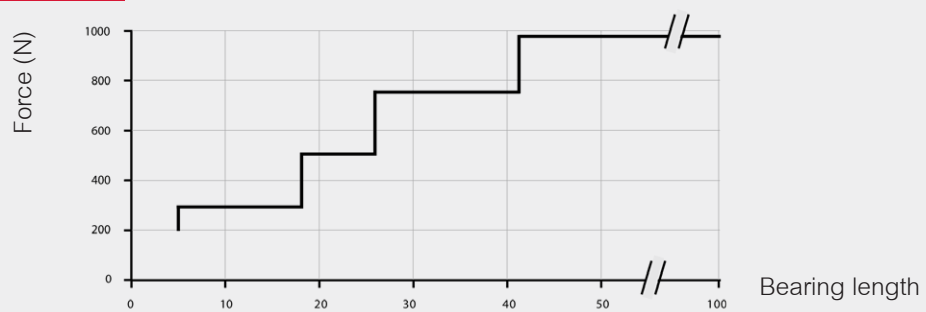

# DIMENSION TABLE LIST FOR SINTERED BRONZE PLAIN BEARINGS

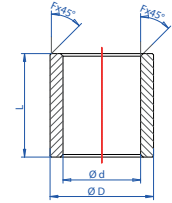

## SINTERED BRONZE BEARINGS

ARTICLE NUMBER	D	D	LENGTH	ARTICLE NUMBER	D	D	LENGTH
SBC 002/004 X ###	2	4	4	SBC 010/016 X ###	10	16	8   10   12   15   16   20   24   25
SBC 002/005 X ###	2	5	2   3	SBC 010/018 X ###	10	18	10   12   15   16   20   25
SBC 003/006 X ###	3	6	4   5   6   7   8   10	SBC 010/020 X ###	10	20	15   24
SBC 003/008 X ###	3	8	4	SBC 010/022 X ###	10	22	20
SBC 004/006 X ###	4	6	4   5   6   8   10	SBC 011/015 X ###	11	15	10   15   20   25
SBC 004/007 X ###	4	7	3   4   6   8   10   12	SBC 011/017 X ###	11	17	15   20
SBC 004/008 X ###	4	8	3   4   5   6   8   10   12	SBC 012/014 X ###	12	14	10   12   15   16   18   20
SBC 004/010 X ###	4	10	8	SBC 012/015 X ###	12	15	10   12   14   15   16   18   20   25
SBC 005/008 X ###	5	8	4   5   8   10   12   15   16	SBC 012/016 X ###	12	16	6   8   10   12   15   16   18   20   25
SBC 005/009 X ###	5	9	4   5   8   10	SBC 012/017 X ###	12	17	10   12   15   16   20   25
SBC 005/010 X ###	5	10	5   6   8   10   12   15	SBC 012/018 X ###	12	18	8   9   10   12   15   16   20   25   30
SBC 005/012 X ###	5	12	10	SBC 012/020 X ###	12	20	12   15   20   25   30
SBC 006/009 X ###	6	9	4   5   6   8   10   12   15   16	SBC 012/025 X ###	12	25	25
SBC 006/010 X ###	6	10	4   5   6   10   12   14   15   16	SBC 014/018 X ###	14	18	10   14   15   18   20   22   24   25   28
SBC 006/012 X ###	6	12	5   6   8   10   12   15   16	SBC 014/020 X ###	14	20	10   12   14   15   18   20   22   25   28   30
SBC 006/014 X ###	6	14	12	SBC 014/022 X ###	14	22	15   20   25   30
SBC 007/010 X ###	7	10	5   8   10	SBC 014/028 X ###	14	28	30
SBC 007/011 X ###	7	11	8   10	SBC 015/018 X ###	15	18	10   15   20   25   30
SBC 007/012 X ###	7	12	10   15	SBC 015/019 X ###	15	19	8   10   15   16   20   25   32
SBC 008/010 X ###	8	10	6   8   10   12   15	SBC 015/020 X ###	15	20	10   12   15   16   20   25   30
SBC 008/011 X ###	8	11	6   8   10   12   16   20	SBC 015/021 X ###	15	21	10   15   16   20   25   32
SBC 008/012 X ###	8	12	6   8   10   12   15   16   20	SBC 015/022 X ###	15	22	15   16   20   25   30
SBC 008/014 X ###	8	14	8   10   12   15   16   20	SBC 015/030 X ###	15	30	30
SBC 008/015 X ###	8	15	10   13   15	SBC 016/020 X ###	16	20	12   14   15   16   18   20   24   25   30   32
SBC 008/016 X ###	8	16	8   12   18	SBC 016/022 X ###	16	22	12   15   16   20   25   30   32   35   40
SBC 008/018 X ###	8	18	16	SBC 016/024 X ###	16	24	30
SBC 009/012 X ###	9	12	6   10   14	SBC 016/032 X ###	16	32	30
SBC 009/013 X ###	9	13	10   12   14	SBC 017/022 X ###	17	22	15   20   25   30   35
SBC 009/014 X ###	9	14	10   12   15   20	SBC 018/022 X ###	18	22	12   13   15   18   20   22   25   28   30   36
SBC 010/013 X ###	10	13	10   12   15   16   19   20   25	SBC 018/024 X ###	18	24	12   15   18   20   22   25   28   30   35   36
SBC 010/014 X ###	10	14	8   10   12   13   14   15   16   18   20   25	SBC 018/025 X ###	18	25	16   18   20   22   25   28   30   35   36
SBC 010/015 X ###	10	15	10   12   15   16   20   25	SBC 018/035 X ###	18	35	30

d = inside diameter | D = outside diameter | Length = total length

## SINTERED BRONZE BEARINGS

ARTICLE NUMBER	D	D	LENGTH	ARTICLE NUMBER	D	D	LENGTH
SBC 019/025 X ###	19	25	30   40	SBC 038/046 X ###	38	46	30
SBC 020/024 X ###	20	24	10   12   16   20   25   30   32	SBC 040/045 X ###	40	45	30   35   40   45   50
SBC 020/025 X ###	20	25	15   16   20   25   30   32   35	SBC 040/046 X ###	40	46	25   30   32   35   37   40   45   50
SBC 020/026 X ###	20	26	10   15   16   20   25   30   32   35   40	SBC 040/050 X ###	40	50	25   30   32   40   45   50   60   80
SBC 020/027 X ###	20	27	16   20   25   32	SBC 045/051 X ###	45	51	28   35   36   45   55   56
SBC 020/028 X ###	20	28	16   20   25   30   32   35   40	SBC 045/055 X ###	45	55	30   35   40   45   50   55   60   65
SBC 020/030 X ###	20	30	20   25   30   35   40	SBC 045/056 X ###	45	56	28   36   45   56
SBC 020/040 X ###	20	40	40	SBC 045/060 X ###	45	60	40   45   50   60
SBC 022/026 X ###	22	26	20   22   25   30	SBC 045/065 X ###	45	65	80
SBC 022/027 X ###	22	27	15   18   20   22   25   28   30   35   36   40	SBC 050/056 X ###	50	56	32   40   50   63
SBC 022/028 X ###	22	28	18   20   22   25   28   30   35   36   40	SBC 050/060 X ###	50	60	32   35   40   45   50   60   63   70   100
SBC 022/029 X ###	22	29	18   22   28   36	SBC 050/070 X ###	50	70	70
SBC 022/030 X ###	22	30	20   25   30	SBC 055/065 X ###	55	65	40   55   60   70
SBC 022/032 X ###	22	32	20   22   25   30   35	SBC 055/070 X ###	55	70	70
SBC 024/028 X ###	24	28	25   30	SBC 060/068 X ###	60	68	50   60   70
SBC 025/030 X ###	25	30	20   25   30   32   35   40	SBC 060/070 X ###	60	70	50   60   90   120
SBC 025/032 X ###	25	32	20   25   30   32   35   40   45	SBC 060/072 X ###	60	72	50   60   70
SBC 025/035 X ###	25	35	25   30   35   40   45   50	SBC 060/075 X ###	60	75	60   90
SBC 025/045 X ###	25	45	35	SBC 060/080 X ###	60	80	70   90   120
SBC 026/030 X ###	26	30	25   30	SBC 060/085 X ###	60	85	90
SBC 028/032 X ###	28	32	20   22   25   28   32   36   40   45	SBC 063/070 X ###	63	70	40   50
SBC 028/033 X ###	28	33	20   22   25   28   32   36   40   45	SBC 065/075 X ###	65	75	60   90
SBC 028/035 X ###	28	35	20   25   30   35   40   45   50	SBC 065/080 X ###	65	80	60   90
SBC 028/036 X ###	28	36	22   25   28   35   36   45	SBC 070/080 X ###	70	80	50   60   90   120
SBC 030/035 X ###	30	35	20   25   30   35   40   45   50	SBC 070/085 X ###	70	85	60   90
SBC 030/038 X ###	30	38	20   24   25   30   35   38   40   45   50	SBC 075/085 X ###	75	85	70   100
SBC 030/040 X ###	30	40	20   25   30   35   40   45   50   60	SBC 075/090 X ###	75	90	70   100
SBC 030/050 X ###	30	50	60	SBC 075/100 X ###	75	100	100
SBC 032/038 X ###	32	38	20   25   32   40   50	SBC 080/090 X ###	80	90	70   100
SBC 032/040 X ###	32	40	20   25   30   32   35   40   45   50	SBC 080/095 X ###	80	95	70   100
SBC 035/040 X ###	35	40	20   25   30   35   40   45   50	SBC 080/100 X ###	80	100	80   120
SBC 035/041 X ###	35	41	25   35   40	SBC 080/105 X ###	80	105	100
SBC 035/044 X ###	35	44	22   28   35	SBC 085/100 X ###	85	100	100
SBC 035/045 X ###	35	45	25   30   35   40   45   50   60   70	SBC 090/105 X ###	90	105	80
SBC 036/042 X ###	36	42	22   28   36   45	SBC 090/110 X ###	90	110	80
SBC 036/045 X ###	36	45	22   28   36   45	SBC 100/120 X ###	100	120	80   120
SBC 038/044 X ###	38	44	25   35   45				

d = inside diameter | D = outside diameter | Length = total length

# DIMENSION TABLE LIST FOR SINTERED BRONZE PLAIN BEARINGS

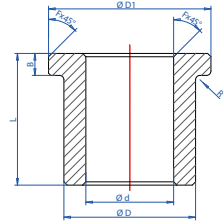

## SINTERED BRONZE FLANGED BEARINGS

ARTICLE NUMBER	D	D	D1	B	LENGTH
SBK 003/005 X ### - 008 X 01.5	3	5	8	1.5	4
SBK 003/006 X ### - 009 X 01.5	3	6	9	1.5	4   5   6   10
SBK 004/008 X ### - 010 X 01.5	4	8	10	1.5	6
SBK 004/008 X ### - 012 X 02	4	8	12	2.0	4   5   6   8   10   12
SBK 005/009 X ### - 013 X 02	5	9	13	2.0	4   5   8
SBK 005/010 X ### - 012 X 02	5	10	12	2.0	6
SBK 006/010 X ### - 014 X 02	6	10	14	2.0	4   6   10   15   16
SBK 006/012 X ### - 014 X 02	6	12	14	2.0	6
SBK 008/012 X ### - 016 X 02	8	12	16	2.0	6   8   10   12   15   16
SBK 008/013 X ### - 016 X 02	8	13	16	2.0	15
SBK 008/014 X ### - 018 X 02	8	14	18	2.0	15
SBK 008/014 X ### - 018 X 03	8	14	18	3.0	8
SBK 008/015 X ### - 018 X 02	8	15	18	2.0	10   15
SBK 008/018 X ### - 018 X 03	8	18	18	3.0	8
SBK 009/014 X ### - 019 X 02.5	9	14	19	2.5	6   10   14
SBK 010/013 X ### - 016 X 01.5	10	13	16	1.5	8   10   16   20
SBK 010/013 X ### - 017 X 02.5	10	13	17	2.5	10   16
SBK 010/014 X ### - 018 X 02	10	14	18	2.0	10   15   20
SBK 010/015 X ### - 020 X 02.5	10	15	20	2.5	10   16   20
SBK 010/015 X ### - 020 X 03	10	15	20	3.0	10   15   16   20
SBK 010/016 X ### - 020 X 03	10	16	20	3.0	8   10
SBK 010/016 X ### - 022 X 03	10	16	22	3.0	8   10   16   20
SBK 012/015 X ### - 018 X 01.5	12	15	18	1.5	7.5   12   16   20
SBK 012/015 X ### - 018 X 02	12	15	18	2.0	8   12   15   16   20
SBK 012/016 X ### - 018 X 02	12	16	18	2.0	15   20
SBK 012/017 X ### - 022 X 02.5	12	17	22	2.5	12   16   20   25
SBK 012/017 X ### - 022 X 03	12	17	22	3.0	10   12   15   16   20   25
SBK 012/018 X ### - 022 X 03	12	18	22	3.0	10   12
SBK 012/018 X ### - 024 X 03	12	18	24	3.0	8   12   20
SBK 014/018 X ### - 022 X 02	14	18	22	2.0	14   18   22
SBK 014/018 X ### - 022 X 03	14	18	22	3.0	20
SBK 014/020 X ### - 025 X 03	14	20	25	3.0	10   12   14   15   18   20   22   25   28   30

d = inside diameter | D = outside diameter | D1 = flange diameter | B = flange thickness | Length = total length

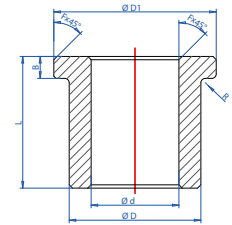

## SINTERED BRONZE FLANGED BEARINGS

ARTICLE NUMBER	D	D	D1	B	LENGTH
SBK 014/020 X ### - 026 X 03	14	20	26	3.0	10   14   18   20   22   28
SBK 015/019 X ### - 023 X 02	15	19	23	2.0	16   20   25
SBK 015/020 X ### - 025 X 03	15	20	25	3.0	15   20   25   30
SBK 015/020 X ### - 027 X 03	15	20	27	3.0	15   25
SBK 015/021 X ### - 027 X 03	15	21	27	3.0	10   15   16   20   25   32
SBK 015/022 X ### - 028 X 03	15	22	28	3.0	12   15   16
SBK 016/020 X ### - 024 X 02	16	20	24	2.0	16   20   25
SBK 016/022 X ### - 028 X 03	16	22	28	3.0	12   15   16   20   25   30   32
SBK 016/022 X ### - 028 X 04	16	22	28	4.0	12   16
SBK 018/022 X ### - 026 X 02	18	22	26	2.0	18   20   22   28
SBK 018/024 X ### - 030 X 03	18	24	30	3.0	12   18   22   28   30
SBK 018/025 X ### - 032 X 04	18	25	32	4.0	12   16   20   25   30   35
SBK 020/024 X ### - 028 X 02	20	24	28	2.0	10   16   20   25
SBK 020/026 X ### - 032 X 03	20	26	32	3.0	15   16   20   25   30   32
SBK 020/028 X ### - 035 X 04	20	28	35	4.0	16   20   25   30   35
SBK 022/027 X ### - 032 X 02.5	22	27	32	2.5	18   22   28
SBK 022/028 X ### - 033 X 04	22	28	33	4.0	15   20   25   30   35   40
SBK 022/028 X ### - 034 X 03	22	28	34	3.0	15   20   25   30
SBK 022/029 X ### - 036 X 03.5	22	29	36	3.5	18   22   28   36
SBK 025/030 X ### - 035 X 02.5	25	30	35	2.5	20   25   30   32
SBK 025/032 X ### - 039 X 03.5	25	32	39	3.5	20   25   30   32
SBK 025/032 X ### - 039 X 05.5	25	32	39	5.5	20
SBK 025/032 X ### - 040 X 04	25	32	40	4.0	20   25   30   32   35   40
SBK 025/035 X ### - 045 X 05	25	35	45	5.0	16   20   25   30
SBK 028/033 X ### - 038 X 02.5	28	33	38	2.5	22   28   36
SBK 028/036 X ### - 044 X 04	28	36	44	4.0	22   25   28   30   35   36   40
SBK 030/035 X ### - 044 X 04	30	35	44	4.0	30   35   40
SBK 030/038 X ### - 046 X 04	30	38	46	4.0	20   25   30
SBK 030/040 X ### - 048 X 04	30	40	48	4.0	25   30   35   40
SBK 030/040 X ### - 050 X 05	30	40	50	5.0	20   30
SBK 032/038 X ### - 044 X 03	32	38	44	3.0	20   25   30   32
SBK 032/040 X ### - 048 X 04	32	40	48	4.0	20   25   30   32   35   40

d = inside diameter | D = outside diameter | D1 = flange diameter | B = flange thickness | Length = total length

# DIMENSION TABLE LIST FOR SINTERED BRONZE PLAIN BEARINGS

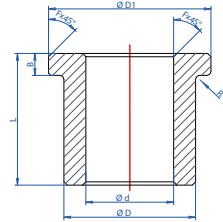

## SINTERED BRONZE FLANGED BEARINGS

ARTICLE NUMBER	d	D	D1	B	LENGTH
SBK 035/045 X ### - 055 X 05	35	45	55	5.0	20   25   30   35   40
SBK 036/042 X ### - 048 X 03	36	42	48	3.0	22   28   36
SBK 036/045 X ### - 054 X 04.5	36	45	54	4.5	22   28   36
SBK 040/046 X ### - 052 X 03	40	46	52	3.0	25   30   32   35   40
SBK 040/048 X ### - 053 X 05	40	48	53	5.0	40
SBK 040/050 X ### - 060 X 05	40	50	60	5.0	25   30   32   35   40   50
SBK 040/050 X ### - 060 X 06	40	50	60	6.0	25   40
SBK 045/051 X ### - 057 X 03	45	51	57	3.0	28   36   45
SBK 045/055 X ### - 065 X 05	45	55	65	5.0	30   35   40   45   55
SBK 045/055 X ### - 065 X 06	45	55	65	6.0	30   45
SBK 045/056 X ### - 067 X 05.5	45	56	67	5.5	28   36   45
SBK 050/056 X ### - 062 X 03	50	56	62	3.0	30   32   40   50
SBK 050/060 X ### - 070 X 05	50	60	70	5.0	32   35   40   45   50
SBK 050/060 X ### - 070 X 06	50	60	70	6.0	30   50
SBK 050/060 X ### - 070 X 10	50	60	70	10.0	27.5
SBK 060/070 X ### - 080 X 05	60	70	80	5.0	30   40   45   50   60
SBK 060/070 X ### - 080 X 06	60	70	80	6.0	40
SBK 060/072 X ### - 084 X 06	60	72	84	6.0	50   60
SBK 060/075 X ### - 085 X 08	60	75	85	8.0	35   60
SBK 070/085 X ### - 095 X 06	70	85	95	6.0	40   50   60
SBK 070/085 X ### - 095 X 08	70	85	95	8.0	60
SBK 080/095 X ### - 105 X 08	80	95	105	8.0	70
SBK 090/110 X ### - 120 X 08	90	110	120	8.0	50
SBK 100/120 X ### - 130 X 08	100	120	130	8.0	80

d = inside diameter | D = outside diameter | D1 = flange diameter | B = flange thickness | Length = total length

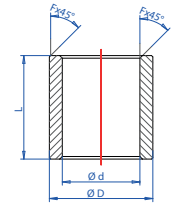

## SINTERED BRONZE BEARINGS (INCH)

ARTICLE NUMBER	D	D	LENGTH	ARTICLE NUMBER	D	D	LENGTH
SIC 03/05 X ##	3	5	4   6   8   10   12   16	SIC 12/20 X ##	12	20	10   12   14   16   18   20   22   24   32
SIC 04/06 X ##	4	6	3   4   6   8   10   12	SIC 14/16 X ##	14	16	12   16   18   20   24
SIC 04/06 X ##	4	6	4   6   8   10   12	SIC 16/18 X ##	16	18	12   16   20   24
SIC 04/08 X ##	4	8	4   6   8   10   12	SIC 16/20 X ##	16	20	12   14   16   20   24
SIC 05/07 X ##	5	7	5   6   8   9   10   12   16	SIC 16/24 X ##	16	24	12   16   20   22   24   28   32
SIC 05/08 X ##	5	8	4   6   8   10   12	SIC 18/22 X ##	18	22	12   16   20   24   28   32
SIC 06/08 X ##	6	8	6   8   10   12   14   16   18   20	SIC 20/24 X ##	20	24	16   20   22   24   28   32
SIC 06/10 X ##	6	10	6   8   10   12   14   16	SIC 20/26 X ##	20	26	16   20   24   28   32   40
SIC 07/09 X ##	7	9	6   8   10   12	SIC 22/26 X ##	22	26	16   20   24   28   32
SIC 07/11 X ##	7	11	8   16	SIC 22/28 X ##	22	28	24
SIC 08/10 X ##	8	10	6   8   10   12   14   16   20	SIC 24/28 X ##	24	28	20   24   28   32   36
SIC 08/11 X ##	8	11	8   10   12   14   16   20	SIC 24/30 X ##	24	30	20   24   28   32   36
SIC 08/12 X ##	8	12	8   10   12   16   18   20   32	SIC 24/32 X ##	24	32	24   32   36   40   48
SIC 09/11 X ##	9	11	8   10   12   16   20	SIC 26/33 X ##	26	33	30   32   40
SIC 09/12 X ##	9	12	16	SIC 28/32 X ##	28	32	20   24   28   32   36
SIC 10/12 X ##	10	12	8   9   10   12   14   16   20	SIC 28/36 X ##	28	36	24   28   32   36
SIC 10/13 X ##	10	13	12   16   20	SIC 32/36 X ##	32	36	24   28   32   40
SIC 10/14 X ##	10	14	8   10   12   14   16   18   20	SIC 32/40 X ##	32	40	24   28   32   36   40   48
SIC 11/15 X ##	11	15	14   16   20	SIC 36/42 X ##	36	42	24   40   48
SIC 12/14 X ##	12	14	8   10   12   14   16   18   20	SIC 36/44 X ##	36	44	24   32
SIC 12/15 X ##	12	15	12   16	SIC 40/46 X ##	40	46	40
SIC 12/16 X ##	12	16	8   10   12   14   16   18   20	SIC 40/48 X ##	40	48	24   32   36   40   48
SIC 12/18 X ##	12	18	12   16   20	SIC 48/56 X ##	48	56	40   48

d = inside diameter | D = outside diameter | Length = total length

### INCH CONVERSION TABLE

01 = $\frac{1}{16}$	02 = $\frac{1}{8}$	03 = $\frac{3}{16}$	04 = $\frac{1}{4}$
05 = $\frac{5}{16}$	06 = $\frac{3}{8}$	07 = $\frac{7}{16}$	08 = $\frac{1}{2}$
09 = $\frac{9}{16}$	10 = $\frac{5}{8}$	11 = $\frac{11}{16}$	12 = $\frac{3}{4}$
14 = $\frac{7}{8}$	16 = 1	18 = $1 \frac{1}{8}$	20 = $1 \frac{1}{4}$
22 = $1 \frac{3}{8}$	24 = $1 \frac{1}{2}$	26 = $1 \frac{5}{8}$	28 = $1 \frac{3}{4}$
30 = $1 \frac{7}{8}$	32 = 2	36 = $2 \frac{1}{4}$	40 = $2 \frac{1}{2}$
42 = $2 \frac{5}{8}$	44 = $2 \frac{3}{4}$	48 = 3	56 = $3 \frac{1}{2}$

# DIMENSION TABLE LIST FOR SINTERED BRONZE PLAIN BEARINGS

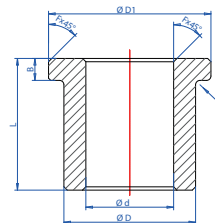

## SINTERED BRONZE FLANGED BEARINGS (INCH)

ARTICLE NUMBER	D	D	D1	B	LENGTH
SIK 03/05 X ## - 06 X 01	3	5	6	1	4   6   8
SIK 04/06 X ## - 08 X 01	4	6	8	1	4   6   8   12
SIK 05/08 X ## - 10 X 01	5	8	10	1	4   6   8   12
SIK 05/09 X ## - 10.5 X 02	5	9	10.5	2	6
SIK 06/08 X ## - 10 X 01	6	8	10	1	8   14
SIK 06/09 X ## - 12 X 01	6	9	12	1	8
SIK 06/10 X ## - 12 X 02	6	10	12	2	6   8   10   12
SIK 07/09 X ## - 12 X 01	7	9	12	1	8   12
SIK 08/10 X ## - 12 X 0.098"	8	10	12	0.098"	8   16
SIK 08/12 X ## - 16 X 02	8	12	16	2	8   12   16   18
SIK 10/12 X ## - 18 X 01.5	10	12	18	1.5	8   16   18
SIK 10/14 X ## - 20 X 02	10	14	20	2	8   12   16   18
SIK 12/16 X ## - 22 X 02	12	16	22	2	12   16   20   24
SIK 14/16 X ## - 20 X 02	14	16	20	2	16
SIK 14/18 X ## - 26 X 02	14	18	26	2	12   16   20   24
SIK 16/20 X ## - 28 X 02	16	20	28	2	16   20   24   28   32
SIK 18/22 X ## - 30 X 02	18	22	30	2	16   20   24   28
SIK 20/24 X ## - 30 X 02	20	24	30	2	12   20   24
SIK 20/26 X ## - 32 X 02	20	26	32	2	16   20   24   28
SIK 22/26 X ## - 30 X 02	22	26	30	2	12   20
SIK 24/28 X ## - 30 X 02	24	28	30	2	24   30
SIK 24/30 X ## - 40 X 03	24	30	40	3	20   24   28   32

d = inside diameter | D = outside diameter | D1 = flange diameter | B = flange thickness | Length = total length

### INCH CONVERSION TABLE

01 = $\frac{1}{16}$	02 = $\frac{1}{8}$	03 = $\frac{3}{16}$	04 = $\frac{1}{4}$
05 = $\frac{5}{16}$	06 = $\frac{3}{8}$	07 = $\frac{7}{16}$	08 = $\frac{1}{2}$
09 = $\frac{9}{16}$	10 = $\frac{5}{8}$	11 = $\frac{11}{16}$	12 = $\frac{3}{4}$
14 = $\frac{7}{8}$	16 = 1	18 = $1 \frac{1}{8}$	20 = $1 \frac{1}{4}$
22 = $1 \frac{3}{8}$	24 = $1 \frac{1}{2}$	26 = $1 \frac{5}{8}$	28 = $1 \frac{3}{4}$
30 = $1 \frac{7}{8}$	32 = 2	36 = $2 \frac{1}{4}$	40 = $2 \frac{1}{2}$
42 = $2 \frac{5}{8}$	44 = $2 \frac{3}{4}$	48 = 3	56 = $3 \frac{1}{2}$



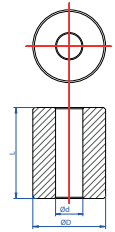

## SINTERED BRONZE CORED BARS FOR MACHINING

ARTICLE NUMBER	D	D	LENGTH
SBH 038/066 X ###	38	66	65   120
SBH 045/105 X ###	45	105	120
SBH 053/085 X ###	53	85	65   120
SBH 059/125 X ###	59	125	80   140
SBH 068/104 X ###	68	104	65   120

ARTICLE NUMBER	D	D	LENGTH
SBH 079/149 X ###	79	149	80   140
SBH 083/123 X ###	83	123	65   120
SBH 098/142 X ###	98	142	65   120
SBH 110/178 X ###	110	178	80   140
SBH 150/202 X ###	150	202	140

d = inside diameter | D = outside diameter | Length = total length

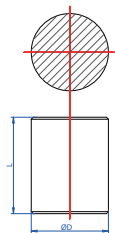

## SINTERED BRONZE BARS FOR MACHINING

ARTICLE NUMBER	D	LENGTH
SBS 015 X ###	15	30
SBS 020 X ###	20	25   50   52
SBS 025 X ###	25	25   50
SBS 030 X ###	30	35   40   50   52
SBS 032 X ###	32	40   80
SBS 040 X ###	40	52
SBS 042 X ###	42	50   100
SBS 045 X ###	45	90
SBS 050 X ###	50	60
SBS 052 X ###	52	60   120

ARTICLE NUMBER	D	LENGTH
SBS 060 X ###	60	60
SBS 062 X ###	62	120
SBS 070 X ###	70	120
SBS 072 X ###	72	60
SBS 080 X ###	80	120
SBS 105 X ###	105	120
SBS 125 X ###	125	80   120
SBS 149 X ###	149	80   140
SBS 178 X ###	178	140
SBS 202 X ###	202	80

D = outside diameter | Length = total length

# PTFE BEARINGS

## DIMENSION TABLE

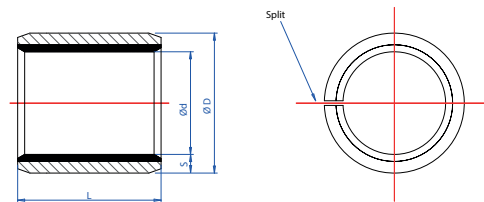

### PTFE BEARINGS WITH STEEL BACKING

ARTICLE NUMBER	D	D	LENGTH
TUP 002.###	2	3.5	3   5
TUP 003.###	3	4.5	3   4   5   6
TUP 004.###	4	5.5	3   4   6   10
TUP 005.###	5	7	4   5   6   8   10
TUP 006.###	6	8	4   5   6   8   10
TUP 007.###	7	9	5   7   10
TUP 008.###	8	10	5   6   8   10   12   15   18
TUP 010.###	10	12	6   8   10   12   15   20
TUP 012.###	12	14	6   8   10   12   15   20   25
TUP 013.###	13	15	10   15   20
TUP 014.###	14	16	10   12   15   20   25
TUP 015.###	15	17	10   12   15   20   25
TUP 016.###	16	18	10   12   15   20   25
TUP 017.###	17	19	12   15   20
TUP 018.###	18	20	10   15   20   25
TUP 020.###	20	23	10   15   20   25   30
TUP 022.###	22	25	11   15   20   25   30
TUP 024.###	24	27	15   20   25   30
TUP 025.###	25	28	12   15   20   25   30   40   50
TUP 026.###	26	30	20   30
TUP 028.###	28	32	15   20   25   30
TUP 030.###	30	34	10   15   20   25   30   40
TUP 032.###	32	36	20   30   40
TUP 035.###	35	39	15   20   30   35   40   45   50
TUP 037.###	37	41	20
TUP 038.###	38	42	25
TUP 040.###	40	44	20   25   30   40   45   50
TUP 042.###	42	46	20
TUP 045.###	45	50	20   30   40   45   50
TUP 050.###	50	55	20   25   30   40   50   60
TUP 055.###	55	60	20   25   30   35   40   50   55   60
TUP 060.###	60	65	20   30   40   50   60   70

ARTICLE NUMBER	D	D	LENGTH
TUP 065.###	65	70	30   40   50   60   70
TUP 070.###	70	75	40   50   60   70
TUP 075.###	75	80	40   50   60   70   80
TUP 080.###	80	85	40   60   80   100
TUP 085.###	85	90	40   60   100
TUP 090.###	90	95	40   50   60   80   90   100
TUP 095.###	95	100	60   80   100
TUP 100.###	100	105	30   40   50   60   70   80   100   115
TUP 105.###	105	110	60   80   100   115
TUP 110.###	110	115	60   80   100   115
TUP 115.###	115	120	50   60   70   115
TUP 120.###	120	125	50   60   100
TUP 125.###	125	130	60   80   100
TUP 130.###	130	135	60   80   100
TUP 135.###	135	140	60   80   100
TUP 140.###	140	145	60   80   100
TUP 145.###	145	150	60   100
TUP 150.###	150	155	60   100
TUP 155.###	155	160	60   100
TUP 160.###	160	165	60   100
TUP 165.###	165	170	60   100
TUP 170.###	170	175	60   100
TUP 175.###	175	180	60   100
TUP 180.###	180	185	60   80   100
TUP 185.###	185	190	60   100
TUP 190.###	190	195	60   100
TUP 195.###	195	200	60   100
TUP 200.###	200	205	60   100
TUP 205.###	205	210	60   100
TUP 210.###	210	215	60   100
TUP 215.###	215	220	60   100
TUP 220.###	220	225	60   100

d = inside diameter | D = outside diameter | Length = total length

## PTFE BEARINGS WITH STEEL BACKING

ARTICLE NUMBER    D    D    LENGTH

TUP 225.###	225	230	60   100
TUP 230.###	230	235	60   100
TUP 235.###	235	240	60   110
TUP 240.###	240	245	60   100
TUP 245.###	245	250	60   100
TUP 250.###	250	255	60   100
TUP 255.###	255	260	60   100
TUP 260.###	260	265	60   100

ARTICLE NUMBER    D    D    LENGTH

TUP 265.###	265	270	60   100
TUP 270.###	270	275	60   100
TUP 275.###	275	280	60   100
TUP 280.###	280	285	60   100
TUP 285.###	285	290	60   100
TUP 290.###	290	295	60   100
TUP 295.###	295	300	60   100
TUP 300.###	300	305	60   100

d = inside diameter | D = outside diameter | Length = total length

## PTFE BEARINGS WITH BRONZE BACKING

ARTICLE NUMBER    D    D    LENGTH

TUP 002.### B	2	3.5	3
TUP 003.### B	3	4.5	2
TUP 004.### B	4	5.5	4   6
TUP 005.### B	5	7	5   8   10
TUP 006.### B	6	8	6   8   10
TUP 008.### B	8	10	8   10   12
TUP 010.### B	10	12	5   8   10   12   15   20
TUP 012.### B	12	14	8   10   12   15   20   25
TUP 013.### B	13	15	10   20
TUP 014.### B	14	16	12   15   20   25
TUP 015.### B	15	17	10   15   20   25
TUP 016.### B	16	18	10   12   15   20   25
TUP 017.### B	17	19	15   20
TUP 018.### B	18	20	15   20   25
TUP 020.### B	20	23	10   15   20   25   30
TUP 022.### B	22	25	20   25   30
TUP 024.### B	24	27	15   20   30
TUP 025.### B	25	28	15   20   25   30   50

ARTICLE NUMBER    D    D    LENGTH

TUP 028.### B	28	32	20   25   30
TUP 030.### B	30	34	20   25   30   40
TUP 032.### B	32	36	20   30
TUP 035.### B	35	39	20   25   30   35   40
TUP 040.### B	40	44	30   40   50
TUP 045.### B	45	50	20   30   40   45   50
TUP 050.### B	50	55	20   30   40   50   60
TUP 055.### B	55	60	20   25   30   40   50   60
TUP 060.### B	60	65	30   40   50   60
TUP 065.### B	65	70	30   50   60
TUP 070.### B	70	75	40   50   60   70
TUP 075.### B	75	80	40   50   60   80
TUP 080.### B	80	85	60   100
TUP 085.### B	85	90	60   100
TUP 090.### B	90	95	60   100
TUP 095.### B	95	100	60   100
TUP 100.### B	100	105	60   115

d = inside diameter | D = outside diameter | Length = total length

# PTFE BEARINGS

## DIMENSION TABLE

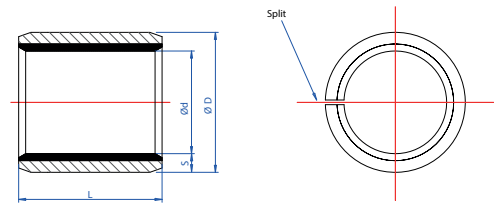

### PTFE BEARINGS WITH STAINLESS STEEL BACKING

ARTICLE NUMBER	d	D	LENGTH
TUP 010.### I	10	12	10   12   15   20
TUP 012.### I	12	14	10   15   20
TUP 014.### I	14	16	15   20   25
TUP 015.### I	15	17	10   15   20
TUP 016.### I	16	18	10   15   20   25
TUP 017.### I	17	19	15
TUP 018.### I	18	20	15   20   25
TUP 020.### I	20	23	10   15   20   25   30
TUP 022.### I	22	25	20   25   30
TUP 024.### I	24	27	20   25   30
TUP 025.### I	25	28	20   25   30   40

ARTICLE NUMBER	d	D	LENGTH
TUP 028.### I	28	32	20   25   30   40
TUP 030.### I	30	34	20   25   30   40
TUP 032.### I	32	36	20   30   40
TUP 035.### I	35	39	20   25   30   40   50
TUP 040.### I	40	44	20   25   30   40   50
TUP 045.### I	45	50	30   40   50
TUP 050.### I	50	55	30   40   50   60
TUP 055.### I	55	60	30   40   50   60
TUP 060.### I	60	65	40   50   60
TUP 075.### I	75	80	40   50   70
TUP 080.### I	80	85	40   60   80

d = inside diameter | D = outside diameter | Length = total length

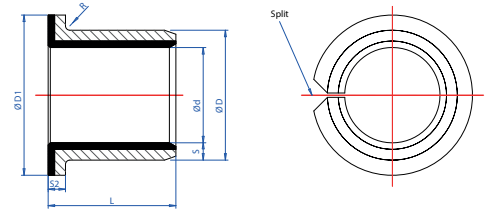

## PTFE FLANGED BEARINGS WITH STEEL BACKING

ARTICLE NUMBER	D	D	D1	S	LENGTH
TUF 003.###	3	4.5	7	0.75	4
TUF 004.###	4	5.5	9	0.75	4
TUF 005.###	5	7	10	1	5
TUF 006.###	6	8	12	1	4   7   8
TUF 008.###	8	10	15	1	5.5   7.5   9.5
TUF 010.###	10	12	18	1	7   9   12   17
TUF 012.###	12	14	20	1	7   9   12   17
TUF 014.###	14	16	22	1	12   17
TUF 015.###	15	17	23	1	9   12   17
TUF 016.###	16	18	24	1	12   17
TUF 018.###	18	20	26	1	12   17   22
TUF 020.###	20	23	30	1.5	11.5   16.5   21.5
TUF 025.###	25	28	35	1.5	11.5   16.5   21.5
TUF 030.###	30	34	42	2	16   26
TUF 035.###	35	39	47	2	16   26
TUF 040.###	40	44	53	2	16   26
TUF 045.###	45	50	58	2.5	16   26   40
TUF 050.###	50	55	65	2.5	20   40
TUF 055.###	55	60	70	2.5	30   40
TUF 060.###	60	65	75	2.5	30   40

d = inside diameter | D = outside diameter | D1 = flange diameter | S = flange thickness | Length = total length

# PTFE BEARINGS

## DIMENSION TABLE

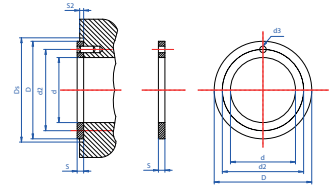

### PTFE THRUST WASHERS

ARTICLE NUMBER	D	D	S	d3	d2	S2
TUW 08	10	20	1.50			
TUW 10	12	24	1.50	1.75	18.00	0.95 / 1.20
TUW 12	14	26	1.50	2.25	20.00	0.95 / 1.20
TUW 14	16	30	1.50	2.25	22.00	0.95 / 1.20
TUW 16	18	32	1.50	2.25	25.00	0.95 / 1.20
TUW 18	20	36	1.50	3.25	28.00	0.95 / 1.20
TUW 20	22	38	1.50	3.25	30.00	0.95 / 1.20
TUW 22	24	42	1.50	3.25	33.00	0.95 / 1.20
TUW 24	26	44	1.50	3.25	35.00	0.95 / 1.20
TUW 25	28	48	1.50	4.25	38.00	0.95 / 1.20
TUW 30	32	54	1.50	4.25	43.00	0.95 / 1.20
TUW 35	38	62	1.50	4.25	50.00	0.95 / 1.20
TUW 40	42	66	1.50	4.25	54.00	0.95 / 1.20
TUW 45	48	74	2.00	4.25	61.00	1.45 / 1.70
TUW 50	52	78	2.00	4.25	65.00	1.45 / 1.70
TUW 60	62	90	2.00	4.25	76.00	1.45 / 1.70

d = inside diameter | D = outside diameter | S = thickness | d2 = perforation circle | d3 = locking hole | S2 = fitting depth

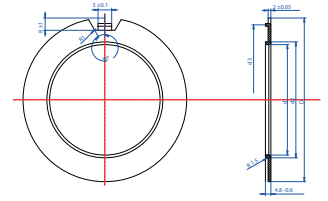

## PTFE FLANGED THRUST WASHERS

ARTICLE NUMBER	D	d2	D	d3
TUWF 40	40.2	44	75	65
TUWF 50	51	55	85	75
TUWF 60	61	65	95	85
TUWF 70	71	75	110	100
TUWF 80	81	85	120	110
TUWF 90	91	95	130	120
TUWF 100	101	105	140	130

d = inside diameter | D = outside diameter | S = thickness | d2 = perforation circle | d3 = locking hole | S2 = fitting depth

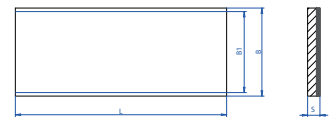

## PTFE STRIPS

ARTICLE NUMBER	L	B	B1	S
TUS 500 x 200 x 0.75	500	200	190	0.72 (± 0.02)
TUS 500 x 200 x 1.00	500	200	190	0.99 (± 0.02)
TUS 500 x 254 x 1.50	500	254	240	1.50 (± 0.02)
TUS 500 x 254 x 2.00	500	254	240	1.98 (± 0.02)
TUS 500 x 254 x 2.50	500	254	240	2.48 (± 0.02)
TUS 500 x 254 x 3.00	500	254	240	3.04 (± 0.02)

L = length | B = width | B1 = usable width | S = thickness

# DIMENSION TABLE FOR POM BEARINGS

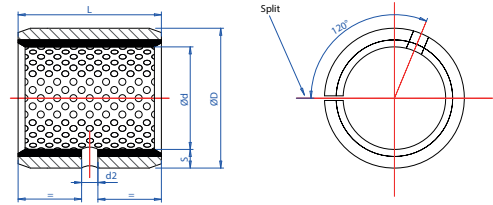

## POM BEARINGS

ARTICLE NUMBER	D	D	LENGTH	ARTICLE NUMBER	D	D	LENGTH
TXP 008.###	8	10	8   10   12	TXP 090.###	90	95	40   60   80   90   100
TXP 010.###	10	12	10   12   15   20	TXP 095.###	95	100	60   100
TXP 012.###	12	14	10   12   15   20	TXP 100.###	100	105	50   60   70   95   115
TXP 014.###	14	16	15   20   25	TXP 105.###	105	110	60   80   100   115
TXP 015.###	15	17	15   20   25	TXP 110.###	110	115	60   110
TXP 016.###	16	18	15   20   25	TXP 115.###	115	120	70
TXP 018.###	18	20	15   20   25	TXP 120.###	120	125	60   100
TXP 020.###	20	23	10   15   20   25   30	TXP 125.###	125	130	60   100
TXP 022.###	22	25	15   20   25   30	TXP 130.###	130	135	60   100
TXP 024.###	24	27	15   20   25   30	TXP 135.###	135	140	60   100
TXP 025.###	25	28	15   20   25   30	TXP 140.###	140	145	60   100
TXP 028.###	28	32	20   25   30	TXP 145.###	145	150	60   100
TXP 030.###	30	34	20   25   30   40	TXP 150.###	150	155	60   100
TXP 032.###	32	36	20   25   30   40	TXP 160.###	160	165	60   100
TXP 035.###	35	39	20   25   30   35   40   50	TXP 165.###	165	170	60   100
TXP 037.###	37	41	20	TXP 170.###	170	175	60   100
TXP 040.###	40	44	20   30   40   50	TXP 180.###	180	185	60   100
TXP 045.###	45	50	20   30   40   45   50	TXP 190.###	190	195	60   100
TXP 050.###	50	55	20   30   40   50   60	TXP 200.###	200	205	60   100
TXP 055.###	55	60	20   30   40   50   60	TXP 220.###	220	225	60   100
TXP 060.###	60	65	30   40   50   60   70	TXP 225.###	225	230	60   100
TXP 065.###	65	70	30   40   50   60   70	TXP 240.###	240	245	60   100
TXP 070.###	70	75	40   50   60   65   70   80	TXP 250.###	250	255	60   100
TXP 075.###	75	80	40   50   60   80	TXP 260.###	260	265	60   100
TXP 080.###	80	85	40   50   60   80   100	TXP 280.###	280	285	60   100
TXP 085.###	85	90	40   60   80   100	TXP 300.###	300	305	60   100

d = inside diameter | D = outside diameter | Length = total length



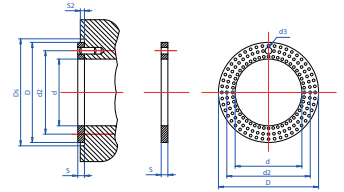

## POM STRIPS

ARTICLE NUMBER	D	D	S	d3	d2	S2
TXW 08	10	20	1.535			
TXW 10	12	24	1.535	1.75	18.00	0.95 / 1.20
TXW 12	14	26	1.535	2.25	20.00	0.95 / 1.20
TXW 14	16	30	1.535	2.25	22.00	0.95 / 1.20
TXW 16	18	32	1.535	2.25	25.00	0.95 / 1.20
TXW 18	20	36	1.535	3.25	28.00	0.95 / 1.20
TXW 20	22	38	1.535	3.25	30.00	0.95 / 1.20
TXW 22	24	42	1.535	3.25	33.00	0.95 / 1.20
TXW 24	26	44	1.535	3.25	35.00	0.95 / 1.20
TXW 25	28	48	1.535	4.25	38.00	0.95 / 1.20
TXW 30	32	54	1.535	4.25	43.00	0.95 / 1.20
TXW 35	38	62	1.535	4.25	50.00	0.95 / 1.20
TXW 40	42	66	1.535	4.25	54.00	0.95 / 1.20
TXW 45	48	74	2.555	4.25	61.00	1.45 / 1.70
TXW 50	52	78	2.555	4.25	65.00	1.45 / 1.70
TXW 60	62	90	2.555	4.25	76.00	1.45 / 1.70

d = inside diameter | D = outside diameter | S = thickness | d2 = perforation circle | d3 = locking hole | S2 = fitting depth

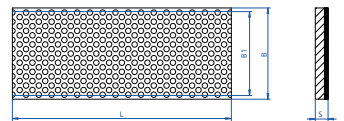

## POM SLIDING PLATES

ARTICLE NUMBER	L	B	B1	S
TXS 500 x 160 x 1.00	500	160	150	1.05 (± 0.02)
TXS 500 x 200 x 1.50	500	200	190	1.54 (± 0.02)
TXS 500 x 200 x 2.50	500	200	190	2.03 (± 0.02)
TXS 500 x 200 x 2.50	500	200	190	2.55 (± 0.02)

L = length | B = width | B1 = usable width | S = thickness

# DIMENSION TABLE FOR WRAPPED BRONZE PLAIN BEARINGS

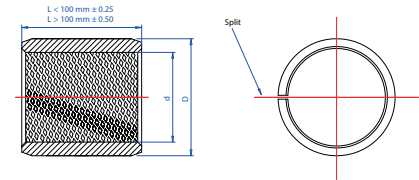

Pockets no. 3 up to Ø 22 mm  
Pockets no. 4 > Ø 22 mm

## WRAPPED BRONZE BEARINGS

ARTICLE NUMBER	D	D	LENGTH	ARTICLE NUMBER	D	D	LENGTH
T90P 010.###	10	12	8   10   15   20	T90P 120.###	120	125	60   100
T90P 012.###	12	14	8   10   12   15   20	T90P 125.###	125	130	60   100
T90P 014.###	14	16	10   15   20   25	T90P 130.###	130	135	60   100
T90P 015.###	15	17	10   15   20   25	T90P 135.###	135	140	60   100
T90P 016.###	16	18	10   15   20   25	T90P 140.###	140	145	60   100
T90P 017.###	17	19	15   20	T90P 145.###	145	150	60   100
T90P 018.###	18	20	10   15   20   25	T90P 150.###	150	155	60   80   100
T90P 020.###	20	23	10   15   20   25   30	T90P 155.###	155	160	60   100
T90P 022.###	22	25	8   10   15   20   25   30   40	T90P 160.###	160	165	60   100
T90P 024.###	24	27	15   20   25   30	T90P 165.###	165	170	60   100
T90P 025.###	25	28	15   20   25   30   50	T90P 170.###	170	175	60   100
T90P 028.###	28	32	15   20   25   30	T90P 175.###	175	180	60   100
T90P 030.###	30	34	15   20   25   30   35   40	T90P 180.###	180	185	60   100
T90P 032.###	32	36	15   20   25   30   35   40   50	T90P 185.###	185	190	60   100
T90P 035.###	35	39	15   20   25   30   35   40   50	T90P 190.###	190	195	60   100
T90P 040.###	40	44	20   25   30   35   40   50   60	T90P 195.###	195	200	60   100
T90P 045.###	45	50	25   30   35   40   50   60	T90P 200.###	200	205	60   100
T90P 050.###	50	55	25   30   35   40   50   60	T90P 205.###	205	210	60   100
T90P 055.###	55	60	25   30   35   40   50   60	T90P 210.###	210	215	60   100
T90P 060.###	60	65	30   35   40   50   60   70	T90P 215.###	215	220	60   100
T90P 065.###	65	70	30   35   40   50   60   70	T90P 220.###	220	225	60   100
T90P 070.###	70	75	35   40   50   60   70   80	T90P 225.###	225	230	60   100
T90P 075.###	75	80	35   40   50   60   70   80	T90P 230.###	230	235	60   100
T90P 080.###	80	85	40   60   80	T90P 240.###	240	245	60   100
T90P 085.###	85	90	40   60   80	T90P 250.###	250	255	60   100
T90P 090.###	90	95	40   50   60   80   90   100	T90P 260.###	260	265	60   100
T90P 095.###	95	100	40   60   80   100	T90P 270.###	270	275	60   100
T90P 100.###	100	105	40   60   80   100	T90P 280.###	280	285	60   100
T90P 105.###	105	110	60   100	T90P 290.###	290	295	60   100
T90P 110.###	110	115	60   100	T90P 300.###	300	305	60   100
T90P 115.###	115	120	60   100				

d = inside diameter | D = outside diameter | Length = total length

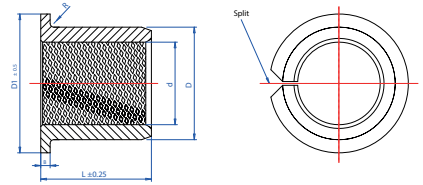

## WRAPPED BRONZE FLANGED BEARINGS

ARTICLE NUMBER	D	D	D1	B	LENGTH
T90F 025.###	25	28	35	1.5	15   25
T90F 030.###	30	34	45	2	20   30
T90F 035.###	35	39	50	2	20   30   35
T90F 040.###	40	44	55	2	25   30   40
T90F 045.###	45	50	60	2.5	25   30   40   45   50
T90F 050.###	50	55	65	2.5	25   30   40   50
T90F 055.###	55	60	70	2.5	30   50
T90F 060.###	60	65	75	2.5	30   50   60
T90F 065.###	65	70	80	2.5	30   50   60
T90F 070.###	70	75	85	2.5	40   60   70
T90F 075.###	75	80	90	2.5	40   60   70
T90F 080.###	80	85	100	2.5	40   50   80
T90F 090.###	90	95	110	2.5	50   90
T90F 095.###	95	100	115	2.5	50   90
T90F 100.###	100	105	120	2.5	50   90
T90F 110.###	110	115	130	2.5	50   90
T90F 120.###	120	125	140	2.5	50   90
T90F 130.###	130	135	155	2.5	60   90
T90F 140.###	140	145	165	2.5	60   90
T90F 150.###	150	155	180	2.5	60   90
T90F 160.###	160	165	190	2.5	60   90
T90F 170.###	170	175	200	2.5	60   90
T90F 180.###	180	185	215	2.5	60   90
T90F 190.###	190	195	225	2.5	60   90
T90F 200.###	200	205	235	2.5	60   90
T90F 225.###	225	230	260	2.5	60   90
T90F 250.###	250	255	290	2.5	60   90
T90F 265.###	265	270	305	2.5	60   90
T90F 285.###	285	290	325	2.5	60   90
T90F 300.###	300	305	340	2.5	60   90

d = inside diameter | D = outside diameter | D1 = flange diameter | B = flange thickness | Length = total length

# DIMENSION TABLE FOR SOLID BRONZE PLAIN BEARINGS

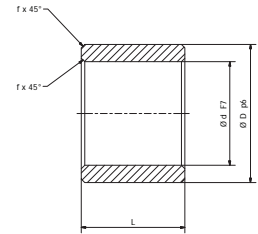

## SOLID BRONZE BEARINGS

ARTICLE NUMBER	d	D	LENGTH	ARTICLE NUMBER	d	D	LENGTH
TBP 005/010 X ###	5	10	6   8   10	TBP 060/075 X ###	60	75	60   90   120
TBP 006/013 X ###	6	13	6   8   12	TBP 065/080 X ###	65	80	60   90   120
TBP 007/012 X ###	7	12	8   10   12	TBP 070/085 X ###	70	85	60   90   120
TBP 008/014 X ###	8	14	8   12   16	TBP 075/090 X ###	75	90	70   100   140
TBP 010/016 X ###	10	16	10   16   20	TBP 080/095 X ###	80	95	70   100   140
TBP 012/018 X ###	12	18	12   16   25	TBP 085/100 X ###	85	100	70   100   140
TBP 014/020 X ###	14	20	12   20   30	TBP 090/110 X ###	90	110	80   120   160
TBP 015/022 X ###	15	22	16   20   30	TBP 095/115 X ###	95	115	80   120   160
TBP 016/022 X ###	16	22	16   20   30	TBP 100/120 X ###	100	120	80   120   160
TBP 017/025 X ###	17	25	16   20   30	TBP 110/130 X ###	110	130	80   140   200
TBP 018/025 X ###	18	25	16   20   30	TBP 120/140 X ###	120	140	80   140   200
TBP 020/028 X ###	20	28	20   30   40	TBP 130/150 X ###	130	150	90   140   200
TBP 022/032 X ###	22	32	20   30   40	TBP 140/160 X ###	140	160	90   160   200
TBP 025/035 X ###	25	35	25   35   5	TBP 150/170 X ###	150	170	100   160
TBP 028/040 X ###	28	40	25   50	TBP 160/180 X ###	160	180	100   160
TBP 030/040 X ###	30	40	30   45   60	TBP 170/190 X ###	170	190	100   160
TBP 035/045 X ###	35	45	35   50   70	TBP 180/200 X ###	180	200	100
TBP 040/050 X ###	40	50	40   60   80	TBP 190/210 X ###	190	210	120
TBP 045/055 X ###	45	55	45   60   80	TBP 200/220 X ###	200	220	120
TBP 050/060 X ###	50	60	50   70   100	TBP 210/230 X ###	210	230	120
TBP 055/070 X ###	55	70	50   70   100				

d = inside diameter | D = outside diameter | Length = total length

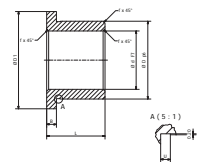

## SOLID FLANGED BRONZE BEARINGS

ARTICLE NUMBER	d	D	D1	B	LENGTH
TBF 005/010 X ### - 012 X 02	5	10	12	2	6
TBF 006/012 X ### - 014 X 02	6	12	14	2	6
TBF 008/014 X ### - 018 X 03	8	14	18	3	8

## SOLID FLANGED BRONZE BEARINGS

ARTICLE NUMBER	D	D	D1	B	LENGTH
TBF 010/016 X ### - 020 X 03	10	16	20	3	8   10
TBF 012/018 X ### - 022 X 03	12	18	22	3	10   12
TBF 014/020 X ### - 025 X 03	14	20	25	3	10   12
TBF 015/022 X ### - 028 X 03	15	22	28	3	12   16
TBF 016/022 X ### - 028 X 04	16	22	28	4	12   16
TBF 018/025 X ### - 032 X 04	18	25	32	4	12   16
TBF 020/028 X ### - 035 X 04	20	28	35	4	16   20
TBF 022/032 X ### - 040 X 05	22	32	40	5	16   20
TBF 025/035 X ### - 045 X 05	25	35	45	5	16   25
TBF 028/040 X ### - 050 X 05	28	40	50	5	16   25
TBF 030/040 X ### - 050 X 05	30	40	50	5	20   30
TBF 035/045 X ### - 055 X 05	35	45	55	5	20   35
TBF 040/050 X ### - 060 X 06	40	50	60	6	25   40
TBF 045/055 X ### - 065 X 06	45	55	65	6	30   45
TBF 050/060 X ### - 070 X 06	50	60	70	6	30   50
TBF 055/070 X ### - 080 X 08	55	70	80	8	30   50
TBF 060/075 X ### - 085 X 08	60	75	85	8	35   60
TBF 065/080 X ### - 090 X 08	65	80	90	8	35   60
TBF 070/085 X ### - 095 X 08	70	85	95	8	35   60
TBF 075/090 X ### - 100 X 08	75	90	100	8	40   70
TBF 080/095 X ### - 105 X 08	80	95	105	8	40   70
TBF 085/100 X ### - 110 X 08	85	100	110	8	40   70
TBF 090/110 X ### - 120 X 08	90	110	120	8	50   80
TBF 095/115 X ### - 125 X 08	95	115	125	8	50   80
TBF 100/120 X ### - 130 X 08	100	120	130	8	50   80
TBF 105/125 X ### - 135 X 08	105	125	135	8	50   80
TBF 110/130 X ### - 140 X 08	110	130	140	8	50   80
TBF 120/140 X ### - 150 X 08	120	140	150	8	50   80
TBF 130/150 X ### - 165 X 10	130	150	165	10	60   90
TBF 140/160 X ### - 175 X 10	140	160	175	10	60   90
TBF 150/170 X ### - 185 X 10	150	170	185	10	70   100
TBF 160/180 X ### - 195 X 10	160	180	195	10	70   100
TBF 170/190 X ### - 205 X 10	170	190	205	10	70   100
TBF 180/200 X ### - 215 X 10	180	200	215	10	100
TBF 190/210 X ### - 225 X 10	190	210	225	10	120
TBF 200/220 X ### - 235 X 10	200	220	235	10	120

d = inside diameter | D = outside diameter | D1 = flange diameter | B = flange thickness | Length = total length

# DIMENSION TABLE FOR MAINTENANCE-FREE PLAIN BEARINGS WITH LUBRICATING PLUGS

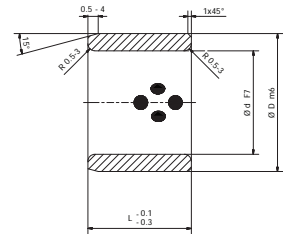

## MAINTENANCE-FREE BEARINGS WITH LUBRICATING PLUGS

ARTICLE NUMBER	D	D	LENGTH	ARTICLE NUMBER	D	D	LENGTH
TOP 008/012 X ###	8	12	8   10   12   15	TOP 050/060 X ###	50	60	30   35   40   50   60   70   80
TOP 010/014 X ###	10	14	8   10   12   15   20	TOP 050/062 X ###	50	62	30   35   40   50   60   70
TOP 012/018 X ###	12	18	10   12   15   16   20   25   30	TOP 050/065 X ###	50	65	30   40   50   60   70   80   100
TOP 013/019 X ###	13	19	10   15   16	TOP 055/070 X ###	55	70	40   50   60   70
TOP 014/020 X ###	14	20	10   12   15   20   25   30	TOP 060/074 X ###	60	74	30   35   40   50   60   70   80
TOP 015/021 X ###	15	21	10   12   15   16   20   25   30	TOP 060/075 X ###	60	75	30   35   40   50   60   70   80   100
TOP 016/022 X ###	16	22	10   12   15   16   20   25   30   35   40	TOP 065/080 X ###	65	80	50   60   70   80
TOP 018/024 X ###	18	24	12   15   16   20   25   30   35   40	TOP 070/085 X ###	70	85	35   40   50   60   70   80   100
TOP 020/028 X ###	20	28	10   12   15   16   20   25   30   35   40   50	TOP 070/090 X ###	70	90	50   60   70   80
TOP 020/030 X ###	20	30	16   20   25   30   35   40	TOP 075/090 X ###	75	90	60   70   80   100
TOP 022/032 X ###	22	32	12   15   20   25	TOP 075/095 X ###	75	95	60   70   80   100
TOP 025/033 X ###	25	33	12   15   16   20   25   30   35   40   50   60	TOP 080/096 X ###	80	96	40   50   60   70   80   100   120
TOP 025/035 X ###	25	35	16   20   25   30   35   40   45   50	TOP 080/100 X ###	80	100	40   50   60   70   80   100   120   140
TOP 030/038 X ###	30	38	15   20   25   30   35   40   50   60	TOP 090/110 X ###	90	110	50   60   70   80   100   120
TOP 030/040 X ###	30	40	20   25   30   35   40   45   50   60	TOP 100/120 X ###	100	120	60   70   80   100   120   140
TOP 035/044 X ###	35	44	30   35   40   50   60	TOP 110/130 X ###	110	130	80   100   120
TOP 035/045 X ###	35	45	20   25   30   35   40   50   60	TOP 120/140 X ###	120	140	80   100   120   140
TOP 040/050 X ###	40	50	20   25   30   35   40   50   60   70   80	TOP 125/145 X ###	125	145	100   120
TOP 040/055 X ###	40	55	30   35   40   50   60	TOP 130/150 X ###	130	150	100   130
TOP 045/055 X ###	45	55	30   35   40   50   60	TOP 140/160 X ###	140	160	100   140
TOP 045/056 X ###	45	56	30   35   40   50   60	TOP 150/170 X ###	150	170	100   150
TOP 045/060 X ###	45	60	30   35   40   50   60   70   80	TOP 160/180 X ###	160	180	100   150

d = inside diameter | D = outside diameter | Length = total length

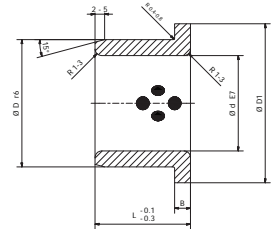

## MAINTENANCE-FREE FLANGED BEARINGS WITH LUBRICATING PLUGS

ARTICLE NUMBER	D	D	D1	B	LENGTH
TOF 010/014 X ### - 022 X 02	10	14	22	2	10   15   20
TOF 012/018 X ### - 025 X 03	12	18	25	3	10   15   20
TOF 014/020 X ### - 027 X 03	14	20	27	3	15   20
TOF 015/021 X ### - 028 X 03	15	21	28	3	10   15   20   25   30
TOF 016/022 X ### - 029 X 03	16	22	29	3	15   20   25   30
TOF 020/030 X ### - 040 X 05	20	30	40	5	15   20   25   30   40
TOF 025/035 X ### - 045 X 05	25	35	45	5	15   20   25   30   40
TOF 030/040 X ### - 050 X 05	30	40	50	5	20   25   30   35   40   50
TOF 035/045 X ### - 060 X 05	35	45	60	5	20   30   40   50
TOF 040/050 X ### - 065 X 05	40	50	65	5	20   30   40   50
TOF 045/055 X ### - 070 X 05	45	55	70	5	30   40   50   60
TOF 050/060 X ### - 075 X 05	50	60	75	5	30   40   50   60
TOF 055/065 X ### - 080 X 05	55	65	80	5	40   60
TOF 060/075 X ### - 090 X 08	60	75	90	7.5	40   50   60   80
TOF 070/085 X ### - 105 X 08	70	85	105	7.5	50   80
TOF 075/090 X ### - 110 X 08	75	90	110	7.5	60
TOF 080/100 X ### - 120 X 10	80	100	120	10	60   70   80   100
TOF 090/110 X ### - 130 X 10	90	110	130	10	60   80
TOF 100/120 X ### - 150 X 10	100	120	150	10	50   80   100
TOF 120/140 X ### - 170 X 10	120	140	170	10	80   100

d = inside diameter | D = outside diameter | D1 = flange diameter | B = flange thickness | Length = total length

# DIMENSION TABLE FOR MAINTENANCE-FREE PLAIN BEARINGS WITH LUBRICATING PLUGS

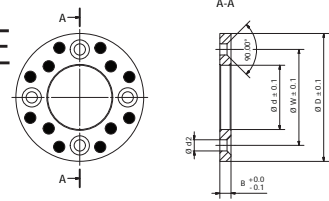

## MAINTENANCE-FREE THRUST WASHERS WITH LUBRICATING PLUGS

ARTICLE NUMBER	d	D	B	W	QUANTITY	d2	COUNTERSUNK SCREW DIN 7991
TOW 010.2/030 X 03	10.2	30	3	20	2	3.5	M3
TOW 012.2/040 X 03	12.2	40	3	28	2	3.5	M3
TOW 013.2/040 X 03	13.2	40	3	28	2	3.5	M3
TOW 014.2/040 X 03	14.2	40	3	28	2	3.5	M3
TOW 015.2/050 X 03	15.2	50	3	35	2	3.5	M3
TOW 016.2/050 X 03	16.2	50	3	35	2	3.5	M3
TOW 018.2/050 X 03	18.2	50	3	35	2	3.5	M3
TOW 020.2/050 X 05	20.2	50	5	35	2	6	M5
TOW 025.2/055 X 05	25.2	55	5	40	2	6	M5
TOW 030.2/060 X 05	30.2	60	5	45	2	6	M5
TOW 035.2/070 X 05	35.2	70	5	50	2	6	M5
TOW 040.2/080 X 07	40.2	80	7	60	2	7	M6
TOW 045.2/090 X 07	45.2	90	7	70	2	7	M6
TOW 050.3/100 X 08	50.3	100	8	75	4	7	M6
TOW 055.3/110 X 08	55.3	110	8	85	4	7	M6
TOW 060.3/120 X 08	60.3	120	8	90	4	9	M8
TOW 065.3/125 X 08	65.3	125	8	95	4	9	M8
TOW 070.3/130 X 10	70.3	130	10	100	4	9	M8
TOW 075.3/140 X 10	75.3	140	10	110	4	9	M8
TOW 080.3/150 X 10	80.3	150	10	120	4	9	M8
TOW 090.5/170 X 10	90.5	170	10	140	4	11	M10
TOW 100.5/190 X 10	100.5	190	10	160	4	11	M10
TOW 120.5/200 X 10	120.5	200	10	175	4	11	M10

d = inside diameter | D = outside diameter | B = thickness | W = perforation circle | d2 = locking hole







# TERMS AND CONDITIONS

## GENERAL TERMS AND CONDITIONS OF SALE FOR TECHNISCHE HANDELSONDERNEMING NEDERLAND B.V.

### Article 1 Definitions

In these terms and conditions, the terms below have the following meanings, unless specifically stated otherwise:

THN : Technische Handelsonderneming Nederland B.V.;  
Buyer : the other party;  
Agreement : the agreement between THN and the Buyer;

### Article 2 General

2.1 The provisions of these terms and conditions apply to all offers, quotations, agreements and any other legal relationship between THN and the Buyer, insofar as the parties have not agreed to deviate from these terms and conditions explicitly and in writing;  
2.2 These terms and conditions also apply to all agreements between THN and the Buyer for the execution of which THN uses the services of third parties;  
2.3 These terms and conditions shall always replace those of the Buyer, unless the parties have agreed otherwise in writing;  
2.4 If THN and the Buyer enter into more than one agreement, these terms and conditions apply to all subsequent agreements, regardless of whether these have been explicitly declared applicable in writing;  
2.5 If one or more of the provisions of these terms and conditions are invalid or should become invalid, the remaining provisions of these terms and conditions will remain in force.

### Article 3 Offers, quotations and agreements

3.1 All offers made by THN in any form are without obligation, unless the offer specifies a time scale for acceptance;  
3.2 Agreements to which THN is party will only become enforceable:  
a) after an agreement drawn up for that purpose has been signed by both parties, or;  
b) after receipt of and agreement with the Buyer's written acceptance of an offer made by THN, or;  
c) by the actual execution of work or delivery of goods by THN;  
3.3 In cases of verbal agreement, the invoice will be deemed to correctly and fully represent the Agreement, unless it is disputed within 14 days of the date of the invoice;  
3.4 If a natural person enters into an Agreement on behalf or on account of another natural or legal person, he or she declares to have the authority to do so by signing the Agreement. Any such person, as well as the other natural or legal person, will be held personally liable for any obligations pursuant to the Agreement;  
3.5 Prices in the aforementioned offers and quotations are in Euro, and exclusive of VAT and other taxes, as well as of any transportation and packaging costs, unless explicitly stated otherwise;  
3.6 If acceptance deviates from the offer stated in a quotation, THN will not be bound by it. The Agreement will not be executed in accordance with any deviations in acceptance, unless THN indicates otherwise;  
3.7 The provision of a compound quotation does not oblige THN to fulfil any part of the obligations included in the offer or quotation against a proportion of the price quoted;  
3.8 Offers or quotations do not apply to any subsequent orders;  
3.9 If a quotation is not accepted, THN has the right to demand fair reimbursement by the party requesting the quotation for any costs related to the production of the quotation.

### Article 4 Execution of the Agreement

4.1 THN cannot be held liable for damage of any kind caused by incorrect or incomplete information provided by the Buyer, unless the error or omission should have been recognised by THN;  
4.2 THN has the right to deliver quantities that deviate within a margin of 5% either way from the quantities agreed between THN and the Buyer.

### Article 5 Supply and completion

5.1 The Buyer is obliged to accept goods and services produced under the Agreement at the moment these are supplied or the order is completed by THN, delivered to the Buyer, or at the moment these are made available to the Buyer pursuant to the Agreement;  
5.2 If the Buyer refuses to accept or fails to provide information or instructions required for supply or completion, THN has the right to store the goods at the expense and risk of the Buyer;  
5.3 If THN requires information from the Buyer with regard to the execution of the Agreement, the supply or completion term will only commence once this has been provided to THN by the Buyer;  
5.4 If THN has set a time scale for supply or completion, it is only indicative. Any supply or completion time scale indicated shall in no case be considered binding. If any such time scale is exceeded, the Buyer must give written notice of default to THN;  
5.5 THN has the right to supply or complete work partially, unless the Agreement states otherwise or where partial supply or completion is of no independent value. THN has the right to invoice separately for partial supply or completion.

### Article 6 Inspection and defects

6.1 The Buyer must inspect the supplied goods or services at the moment of supply or completion. In doing so, the Buyer should inspect whether the quality and quantity of the goods or services supplied or completed comply with what has been agreed, or with the requirements expected in normal (trading) transactions;  
6.2 THN should be notified in writing of any visible defects within 8 days of supply or completion. Invisible defects should be reported in writing within 8 days of discovery but no later than 3 months after supply or completion;  
6.3 THN must be allowed to inspect any reported defects;  
6.4 If timely notice of defects was given and the defects have been verified by THN, THN will repair the defects or shortcomings within a reasonable time scale, or replace the goods or services that have been supplied or completed. Nonetheless, the Buyer will remain obliged to pay for work carried out and goods delivered;  
6.5 If timely notice of any defect was not given or if the Buyer has put to use the goods or services supplied or completed, these will be deemed to have been supplied or completed satisfactorily;  
6.6 If the Buyer wishes to return defective goods, this may only be done with the prior written permission of THN and in the manner indicated by THN.

### Article 7 Compensation, price and costs

7.1 THN has the right to demand a deposit amount of 10 to 50% of the agreed price before work is commenced;  
7.2 If THN has agreed a fixed price with the Buyer, THN reserves the right to increase that price in the cases stated below;  
7.3 THN has the right to pass on to the Buyer changes in costs relating to social contributions, turnover taxes, exchange rates, wages, raw materials, semi-products, packaging materials or other costs occurring after the Agreement was made.

### Article 8 Changes to the Agreement

8.1 If during the execution of the Agreement it becomes apparent that in order to deliver satisfactory results it is necessary to change or supplement the work being carried out, the parties should amend the Agreement to that effect in a timely and mutually agreed manner;  
8.2 If the parties change and/or supplement the Agreement, the time of completion may be affected. THN will notify the Buyer of this as soon as possible;  
8.3 If changes and/or additions to the Agreement have financial and/or qualitative consequences, THN will notify the Buyer of this in advance;

### Article 9 Payment

9.1 Payment must be made either in cash upon supply or completion, or within 30 days of the date of the invoice, in the manner indicated by THN and in the currency on the invoice. Disagreements about the amount of an invoice do not defer the Buyer's obligation to pay;  
9.2 If the Buyer fails to pay within the 30-day term, he or she is considered to be in default in the eyes of the law. The Buyer shall then owe interest of 1% per month or part thereof, unless the statutory interest or the statutory commercial interest (after 30 days) is higher, in which case the higher interest applies. The interest on the outstanding amount will be calculated from the moment the Buyer enters default until the moment the full amount has been received;  
9.3 If the Buyer enters into liquidation, petitions for or enters into bankruptcy, requests or is granted debt rescheduling under the Dutch Natural Persons Debt Rescheduling Act, is repossessed or is granted (temporary) suspension of payment, the outstanding sums the Buyer owes THN will become due immediately;

### Article 10 Retention of title

10.1 All materials and other goods delivered by THN will remain the property of THN until the Buyer has met all obligations towards THN;  
10.2 The Buyer has no authority to sell, provide as security or otherwise encumber goods falling under retention of title rights;  
10.3 With immediate effect, the Buyer gives unconditional and irrevocable permission for THN or any third parties it appoints to enter any premises that contain THN's property and to repossess these goods, should THN wish to exercise its retention of title rights as defined in this article.

### Article 11 Transfer of risk

11.1 The risk of loss of or damage to goods produced by THN will be transferred to the Buyer from the moment these goods are legally or actually supplied or the order is completed, and thus brought into the ownership of the Buyer or a third party appointed by the Buyer.

### Article 12 Collection costs

12.1 If the Buyer defaults on or neglects to fulfil his obligations (in a timely manner), the Buyer will be liable for all reasonable costs incurred in extrajudicial enforcement. In any case, the Buyer must pay collection costs if a monetary demand is made. Collection costs will be calculated in accordance with the collection cost rate recommended for collection cases by the Netherlands Bar, with a minimum cost of EUR 350.  
12.2 If THN has incurred higher costs, and these were necessary and reasonable, the Buyer will also be liable for these costs. Any reasonable legal and execution costs incurred will also be charged to the Buyer.

### Article 13 Suspension and dissolution

13.1 In addition to the provisions of the law, THN has the authority to defer the fulfilment of its obligations or dissolve the Agreement if it becomes apparent to THN after the Agreement has been made that there are circumstances as a consequence of which THN has good reason to expect that the Buyer will not fulfil, or only partially fulfil his or her obligations, or not fulfil them in a timely manner. If there is good reason to expect that the Buyer will only partially or not satisfactorily fulfil his or her obligations, the dissolution of the Agreement is only permitted if justified by the shortcoming, or if the Buyer was asked to guarantee the fulfilment of his or her obligations at the time the Agreement was made, and this guarantee is not provided or is insufficient.  
13.2 In addition, THN has the authority to dissolve or cause the Agreement to be dissolved if circumstances are such that fulfilment of the Agreement is impossible or can reasonably and fairly be deemed to no longer be possible, or if other circumstances mean that fulfilment of the Agreement in its present form cannot reasonably be expected, without THN becoming liable for damages to the Buyer;  
13.3 If the Agreement is dissolved, any sums owed to THN by the Buyer will become due immediately. If THN defers the fulfilment of its obligations, it will retain its rights under the law and the Agreement;  
13.4 THN reserves the right to demand damage compensation in any case.

### Article 14 Liability

14.1 If THN should incur any liability, it will be limited in accordance with the provisions of this article.  
14.2 THN can only be held liable for wilful damage or damage resulting from neglect by THN or its subordinates.  
14.3 If THN is held liable, liability will be limited to the maximum compensation amount due to be paid by THN's insurer, and liability shall not exceed the invoice amount for the (partial) work concerned.  
14.4 THN will not in any case be held liable for damage caused by advice it provides. Any advice will be given based on the facts and circumstances known to THN and in mutual discussion with the Buyer, in which THN will take the Buyer's intentions as a guide and starting point.  
14.5 THN will never be held liable for indirect damage, being consequential damage, lost profit, missed savings and damage from business stagnation.  
14.6 THN must be notified immediately and in writing of any damage claims and in any case no later than within five working days of the damage occurring.

### Article 15 Force majeure

15.1 THN is not bound to the fulfilment of any obligation if it is impeded from doing so by circumstances not caused wilfully or through neglect by THN and not attributable to THN either in the eyes of the law, through a legal exchange or by general accepted industry opinion;  
15.2 In addition to the provisions of the law and the courts, in these general terms and conditions force majeure includes any expected or unexpected external causes which THN cannot influence, and which cause THN to be unable to fulfil its obligations. This includes labour strikes at THN, staff illness, theft, traffic delays, frost, rain and failure of suppliers to deliver materials;  
15.3 THN also has the right to seek recourse to force majeure if the circumstances that impede (further) fulfilment occur after THN should have fulfilled its obligation;  
15.4 THN can defer its obligations for the duration of the force majeure circumstances. If this period is longer than two months, THN has the right to dissolve the Agreement without incurring liability for damages to the Buyer;  
15.5 If THN has partially fulfilled or will be able to partially fulfil its obligations under the Agreement at the time of the force majeure circumstances and the fulfilled part or part to be fulfilled respectively is deemed to have independent value, THN has the right to invoice separately for the fulfilled part or part to be fulfilled respectively. The Buyer must pay this invoice as if it were a separate Agreement.

### Article 16 Disputes

16.1 The court of law in THN's locality has the exclusive jurisdiction to settle any disputes.

### Article 17 Governing law

17.1 The laws of the Netherlands apply to any Agreement between THN and the Buyer.



THN

Hendrik ter Kuilestraat 30  
7547 BD Enschede  
the Netherlands

+31 (0)53 432 34 46

[www.thn.nl](http://www.thn.nl)