



PISTON RINGS

Published by:

Technische Handelsonderneming Nederland B.V. (THN)

Office address:

Hendrik ter Kuilestraat 30
7547 BD Enschede, the Netherlands

Contact:

Tel.: +31 (0)53 432 34 46
Fax: +31 (0)53 430 71 58

Email: info@thn.nl

Website: www.thn.nl

Version 1.0



Copyright © THN — All rights reserved

THN has compiled this brochure with great care. At the time of going to press, all data included in this brochure is up to date for the latest range of products. All information and all technical specifications have also been checked carefully. However, in the event of any advertent errors or omissions with regard to qualities, capacities, types or otherwise, THN cannot be held liable in any way.

No part of this publication may be reproduced, stored in an automated data file or made public in any form or by any means, whether electronic, mechanical or by photocopying, recording or any other method, without the prior written permission of the publisher. Reproduction of this brochure without the written permission of the publisher is also not permitted.

THN specializes in technical products which we can deliver rapidly with smart stocks and efficient logistics. Our aim is to score 100% customer satisfaction at all times, and we're improving all the time as we work hard day after day. We can also build on the more than 75 years of experience which THN has accumulated, and on our three pillars: commitment, innovation and delivery.

For THN it's all about the customer. That is because we get involved, helping each other as colleagues and as a team for our customers. For when developments need change, we will innovate. To serve you - the customer - even better. And so we can deliver what you need.

You will find everything about our range of piston rings in this brochure. THN has over 4 million piston rings in stock in 20,000 different sizes and types. A major portion of this stock comprises piston rings between 30 mm and 150 mm in diameter.

As well as its standard components, THN can produce custom piston rings that meet the client's exact specification. For these rings, there is a minimum lead time of 24 hours.

As you can see. At THN, you've come to the right place for piston rings. You can be assured of sourcing the very best piston rings on the market and of super-fast delivery too.

1940

THN is established as a technical wholesaler



1970

THN specializes in piston rings



1974

THN adds plain bearings to its range



2007

THN adds linear components to its range



2015

THN celebrates its 75th anniversary

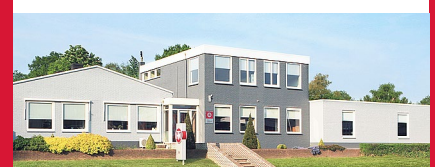

CONTENTS

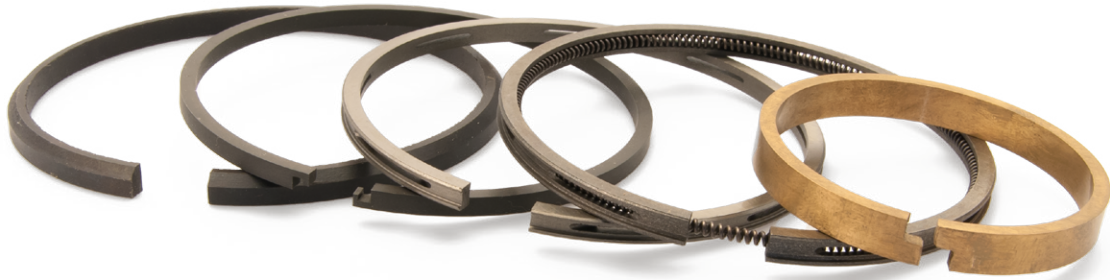

PISTON RINGS

05

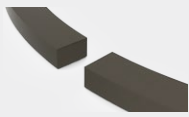

COMPRESSION RINGS

11

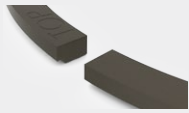

SCRAPER RINGS

12

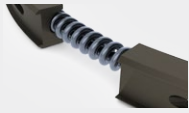

OIL CONTROL RINGS

13

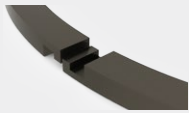

JOINT TYPES

14

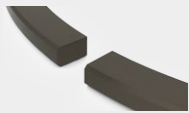

OPTIONS

16

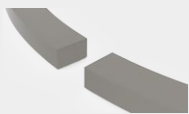

COATINGS

17

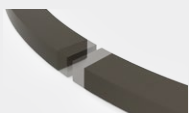

JOINT GAP

18

FUNCTION OF PISTON RINGS

07

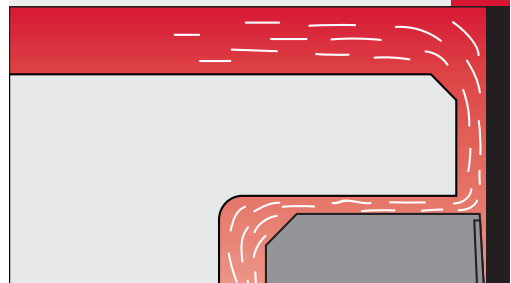

SEALING

09

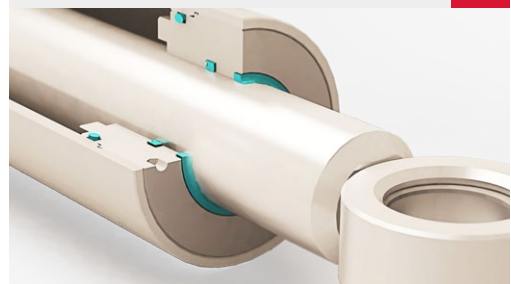

DIMENSIONS

10

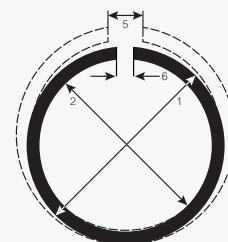

THN ensures its product offering is always up-to-date by training a keen eye on the market. For as well as piston rings, THN also has a wide range of plain bearings, Fey laminar rings, sintered filters and linear components.

How can we assist you with our other products?



PLAIN BEARINGS



- 1 million plain bearings in stock
- over 6,500 sizes and models
- custom plain bearings also available

Fey LAMINAR RINGS



- high-quality steel seals
- internal/external clamping or combined
- types available up to +700 °C

SINTERED FILTERS



- sintered silencers
- a wide range of products in stainless steel and bronze
- custom design sintered filters

LINEAR COMPONENTS



- hardened ground shafts
- shaft support rails
- linear ball bearings and bearing housings

PISTON RINGS

GENERAL

Piston rings are found in all piston engines and in many compressors and pumps.

Piston rings are also found in many other applications such as gearboxes, turbochargers and gasification plants.

They provide a seal as well as lubrication and thermal conduction between the piston and the cylinder wall.

MATERIALS

Piston rings are manufactured from many different materials, with cast iron and steel being the most common. Some more common materials are:

- Gray cast iron (incl. GG25)
- Nodular cast iron (incl. GGG50)
- Bronze (incl. CuSn7 and CuSn10)
- (Stainless) steel (incl. X90CrMoV18 and 54SiCr6)

QUALITY

For the most part, piston rings are produced to comply with DIN and ISO standards. Some of the more common standards are:

- ISO 662x series
- DIN 709xx series
- DIN 2491x series





DESIGN

When designing a piston ring, consideration must be given to factors such as the application and sealing requirements, running characteristics and the expansion of materials. We will be happy to advise you on the design of a piston ring seal.

TEST

Testing is an essential part of any design. These days a lot of things can be calculated, but with a new design, a running and assembly test under actual operating conditions must always be carried out in order to verify the design.



CUSTOM MADE

If the required rings are not in stock, they can be specially produced to order in any desired size and type. These custom orders have a minimum lead time of 24 hours.

FUNCTION OF PISTON RINGS

INTERNAL COMBUSTION ENGINES

Piston rings play a very important part in internal combustion engines. They must absorb the combustion pressure, cool the piston, keep the oil in the crankcase and provide a film of oil on the cylinder wall.

Most modern 4-stroke engines are usually fitted with three piston rings per cylinder. The first ring holds back the combustion gases. The second ring helps to hold back combustion gases and also scrapes the oil downward. The third ring holds the oil where it needs to be. Older engines and industrial engines often have more than three rings (some as many as six per cylinder) where their functions are shared out more.

COMPRESSION RING



The top ring seals tight against the cylinder wall and so holds back most of the combustion gases. The top ring also plays an important part in dissipating the heat from the piston to the cylinder wall.

MATERIALS

- Cast iron
- Nodular cast iron
- Steel
- Stainless steel

COATINGS

- Chrome
- Plasma Molybdenum (moly)
- Nitride
- Phosphate

SCRAPER RING

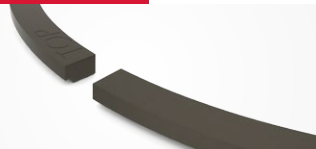

The scraper ring seals off the combustion gases, helps to dissipate the heat from the piston to the cylinder wall and lubricates and scrapes the oil from the cylinder wall towards the oil control ring. This prevents the oil from entering the combustion chamber.

MATERIALS

- Cast iron
- Nodular cast iron
- Steel

COATINGS

- Phosphate

OIL CONTROL RING



The oil control ring disperses and regulates the oil on the cylinder wall and scrapes the oil back down to the crankcase. This is necessary to ensure that the cylinder wall always has a thin, cooler film of oil from the crankcase. This guarantees that the friction between the piston and the cylinder is reduced so as to regulate the generation of heat.

MATERIALS

- Cast iron
- Nodular cast iron
- Steel

COATINGS

- Chrome
- Phosphate
- Nitride

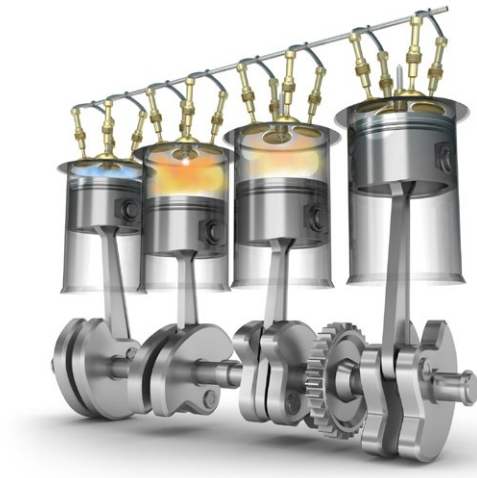
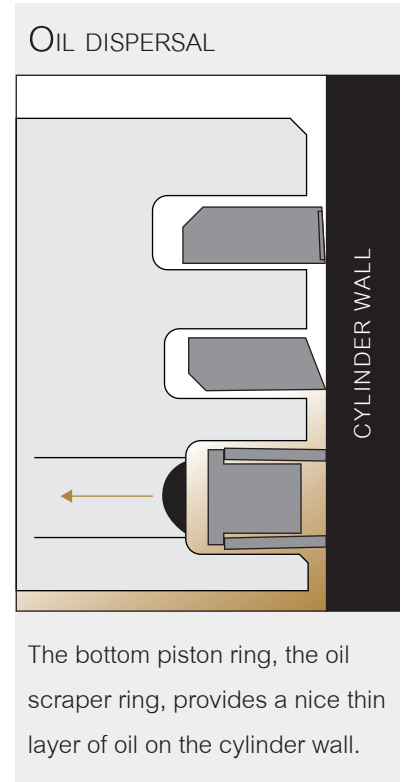
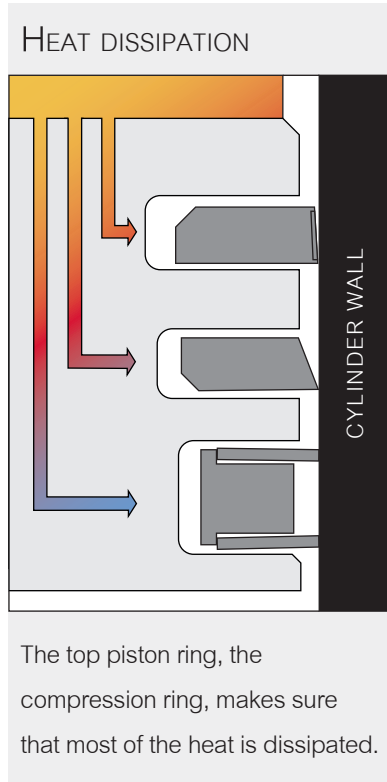
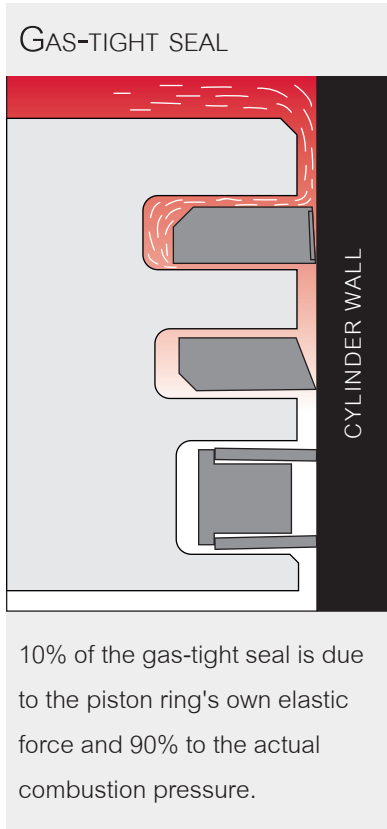

SPOTLIGHT ON COMBUSTION

Because a piston ring is elastic, its own elastic force is always pressing it against the cylinder wall. However, this elastic force is only 10% of the total force with which the compression ring is pressed against the cylinder wall, because no less than 90% of the force comes from the actual combustion pressure.

As a result, the compression ring is pressed down into the piston groove by the combustion pressure. As a consequence, the combustion gas can flow through the axial groove clearance to the inside of the piston. From there, the gas pressure provides the extra sealing force for the piston ring.

When the engine is idling, more oil escapes toward the combustion chamber and the exhaust manifold. This is due to the less efficient filling of the combustion chamber as a result of which the gas pressure has less sealing force.

SEALING

HYDRAULIC

Piston rings are also frequently used in hydraulic applications. They are found in control valves, pumps and cylinders in particular.

In these applications, the piston rings are regularly used in conjunction with non-metallic seals.

This combination gives the metallic piston ring great strength and makes for a virtually hermetic soft seal.

PNEUMATIC

Piston rings are also extensively used in pneumatic applications, with reciprocating compressors being probably the most familiar.

Here the piston rings have a function equivalent to that in an internal combustion engine.

The piston rings seal off the compression chamber, ensure that heat is transferred, regulate the oil film on the cylinder wall and scrape the surplus oil back into the crankcase.

ROTARY

Rotary seals with their (greater) pressures, high temperatures or aggressive media are often troublesome and it is in such situations that piston rings can offer a widely used solution.

As piston rings are metallic, they are very hard, strong and are temperature-resistant.

Once the system is running, and given the correct lubrication, the piston rings generate almost no resistance and so make the system highly efficient.



SIZES

DIMENSIONS AND OPTIONS

Outside diameter (1):	The outside diameter (OD) of the piston ring when fitted in the cylinder
Inside diameter (2):	The inside diameter (ID) of the piston ring when fitted in the cylinder
Axial height (3):	The height of the ring in the axial (vertical) direction, from the top to the bottom of the ring
Radial wall thickness (4):	The ring's width in the radial (horizontal) direction, ID to OD dimension
Free joint gap (5):	The opening of the piston ring in the free (non-fitted) condition
Joint gap (6):	The joint gap of the piston ring when fitted in the cylinder
Rear gap (7):	When fitted, the distance between the bottom of the piston groove and the inside diameter of the piston ring (horizontal measurement)
Groove gap (8):	When fitted, the distance between the axial height of the piston ring and the piston groove (vertical measurement)

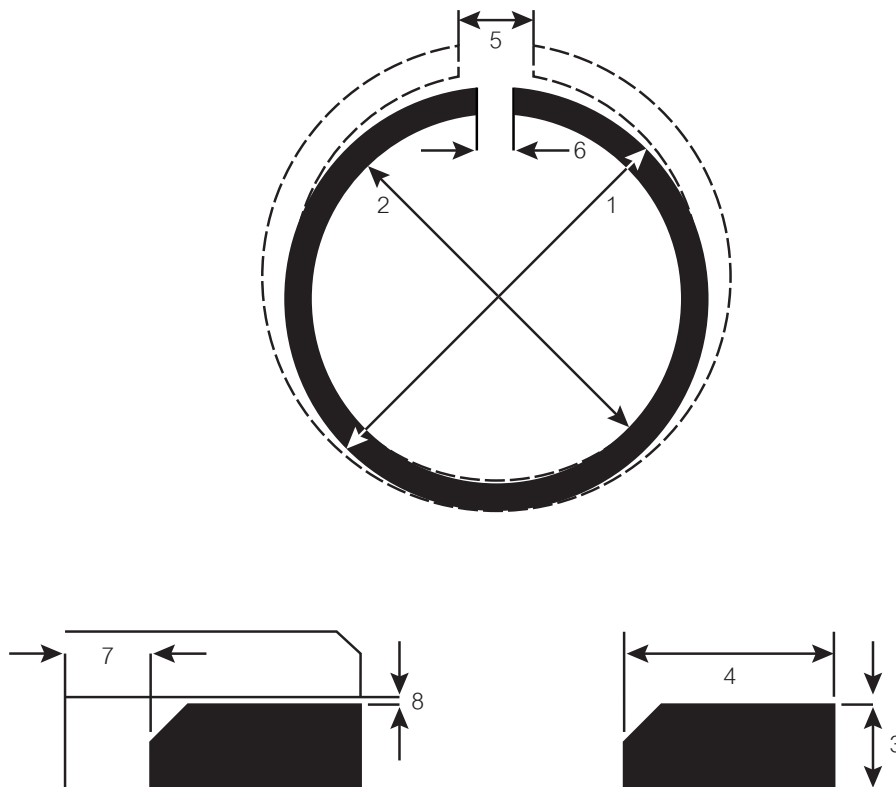

CODING STRUCTURE

The coding structure for the type, version and size is as follows:



[cylinder diameter] x [axial height] x [radial width] [type] [coating] [joint type] [extra]

PISTON RING TYPES



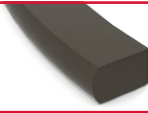
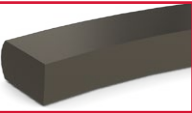

COMPRESSION RINGS

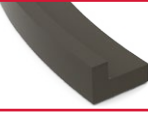
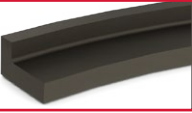
TYPE	SECTION	DESCRIPTION	OUTSIDE	INSIDE
C1		RECTANGULAR COMPRESSION RING		
C2		TAPER FACED COMPRESSION RING		
C3		INTERNALLY BEVELED COMPRESSION RING		
C4		INTERNALLY STEPPED COMPRESSION RING		
C5		RIDGE DODGER RING		
C6		KEYSTONE COMPRESSION RING		
C7		HALF-KEYSTONE COMPRESSION RING		
C8		TAPER FACED SCRAPER RING		

COMPRESSION RINGS

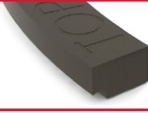

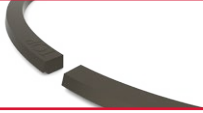
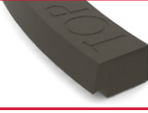

















TYPE	SECTION	DESCRIPTION	OUTSIDE	INSIDE
C9		BARREL FACED COMPRESSION RING		
CL		L-RING		

SCRAPER RINGS





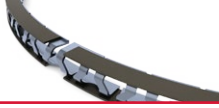









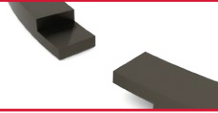

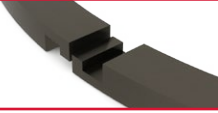
TYPE	SECTION	DESCRIPTION	OUTSIDE	INSIDE
S11		NAPIER RING		
S13		TAPER FACED NAPIER RING		

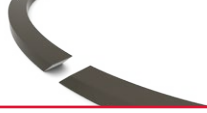
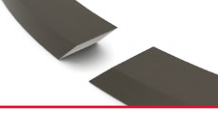
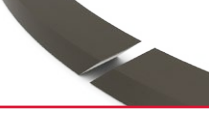
PISTON RING TYPES

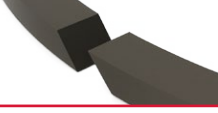
OIL CONTROL RINGS

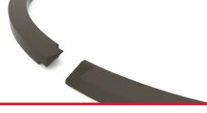
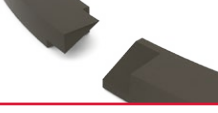

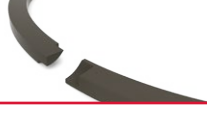
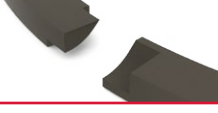



TYPE	SECTION	DESCRIPTION	OUTSIDE	INSIDE
O21		OIL CONTROL RING		
O23		DOUBLE-BEVELED OIL CONTROL RING		
O25		BEVELED OIL CONTROL RING		
WO21		COIL SPRING LOADED SLOTTED OIL CONTROL RING		
WO23		COIL SPRING LOADED DOUBLE-BEVELED OIL CONTROL RING		
WO25		COIL SPRING LOADED BEVELED-EDGE OIL CONTROL RING		
3XO		3-PIECE STEEL OIL CONTROL RING		

JOINT TYPES

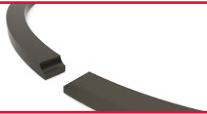
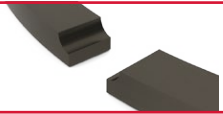
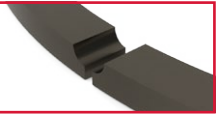
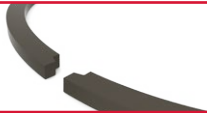









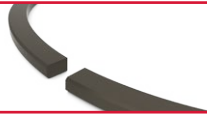
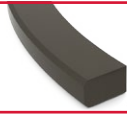

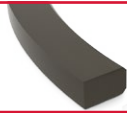



JOINT TYPES				
TYPE	SECTION	DESCRIPTION	OPEN	CLOSED
-		STANDARD JOINT		
BS		LAP JOINT		
HS		HOOK LAP JOINT		
SSR		BEVEL JOINT RIGHT		
SSL		BEVEL JOINT LEFT		
GS		GAS-TIGHT JOINT		
GSW		GAS-TIGHT JOINT		

JOINT TYPES

JOINT TYPES

TYPE	SECTION	DESCRIPTION	OPEN	CLOSED
E		SIDE JOINT		
Z		INNER JOINT		
K		ENLARGED JOINT		

OPTIONS

OPTIONS				
TYPE	SECTION	DESCRIPTION	OUTSIDE	INSIDE
KA		OUTSIDE EDGES BROKEN		
KI		INSIDE EDGES BROKEN		
IF		INTERNALLY BEVELED		
IFU		INTERNALLY BEVELED BOTTOM		
IW		INTERNALLY STEPPED		
IWU		INTERNALLY STEPPED BOTTOM		

COATINGS

COATINGS

TYPE	DESCRIPTION
------	-------------

D	CHROME-PLATED
---	---------------

M	MOLYBDENUM FILLED
---	-------------------

T	TINNED
---	--------

N	NITRIDED
---	----------

P	BLACK PHOSPHATED
---	------------------

F	FERROX-FILLED
---	---------------

JOINT GAP

STANDARD JOINT GAP

Diameter (mm)	Compression ring (mm)	Oil control ring (mm)
45 to 60 mm	0.20 - 0.35	0.15 - 0.30
60 to 75 mm	0.25 - 0.40	0.20 - 0.35
75 to 90 mm	0.30 - 0.45	0.25 - 0.45
90 to 105 mm	0.35 - 0.55	0.25 - 0.45
105 to 120 mm	0.40 - 0.60	0.30 - 0.50
120 to 135 mm	0.45 - 0.65	0.35 - 0.55
135 to 150 mm	0.50 - 0.70	0.40 - 0.60

STANDARD RECOMMENDED VALUES

The above overview gives the standard recommended values for piston rings in the assembled condition. It is always advisable to carry out another check in the cylinder when the rings have been fitted.

NOTES

TERMS AND CONDITIONS

GENERAL TERMS AND CONDITIONS OF SALE FOR TECHNISCHE HANDELSONDERNEMING NEDERLAND B.V.

Article 1 Definitions

In these terms and conditions, the terms below have the following meanings, unless specifically stated otherwise:

THN : Technische Handelsonderneming Nederland B.V.;
Buyer : the other party;
Agreement : the agreement between THN and the Buyer;

Article 2 General

2.1 The provisions of these terms and conditions apply to all offers, quotations, agreements and any other legal relationship between THN and the Buyer, insofar as the parties have not agreed to deviate from these terms and conditions explicitly and in writing;
2.2 These terms and conditions also apply to all agreements between THN and the Buyer for the execution of which THN uses the services of third parties;
2.3 These terms and conditions shall always replace those of the Buyer, unless the parties have agreed otherwise in writing;
2.4 If THN and the Buyer enter into more than one agreement, these terms and conditions apply to all subsequent agreements, regardless of whether these have been explicitly declared applicable in writing;
2.5 If one or more of the provisions of these terms and conditions are invalid or should become invalid, the remaining provisions of these terms and conditions will remain in force.

Article 3 Offers, quotations and agreements

3.1 All offers made by THN in any form are without obligation, unless the offer specifies a time scale for acceptance;
3.2 Agreements to which THN is party will only become enforceable:
a) after an agreement drawn up for that purpose has been signed by both parties, or;
b) after receipt of and agreement with the Buyer's written acceptance of an offer made by THN, or;
c) by the actual execution of work or delivery of goods by THN;
3.3 In cases of verbal agreement, the invoice will be deemed to correctly and fully represent the Agreement, unless it is disputed within 14 days of the date of the invoice;
3.4 If a natural person enters into an Agreement on behalf or on account of another natural or legal person, he or she declares to have the authority to do so by signing the Agreement. Any such person, as well as the other natural or legal person, will be held personally liable for any obligations pursuant to the Agreement;
3.5 Prices in the aforementioned offers and quotations are in Euro, and exclusive of VAT and other taxes, as well as of any transportation and packaging costs, unless explicitly stated otherwise;
3.6 If acceptance deviates from the offer stated in a quotation, THN will not be bound by it. The Agreement will not be executed in accordance with any deviations in acceptance, unless THN indicates otherwise;
3.7 The provision of a compound quotation does not oblige THN to fulfil any part of the obligations included in the offer or quotation against a proportion of the price quoted;
3.8 Offers or quotations do not apply to any subsequent orders;
3.9 If a quotation is not accepted, THN has the right to demand fair reimbursement by the party requesting the quotation for any costs related to the production of the quotation.

Article 4 Execution of the Agreement

4.1 THN cannot be held liable for damage of any kind caused by incorrect or incomplete information provided by the Buyer, unless the error or omission should have been recognised by THN;
4.2 THN has the right to deliver quantities that deviate within a margin of 5% either way from the quantities agreed between THN and the Buyer.

Article 5 Supply and completion

5.1 The Buyer is obliged to accept goods and services produced under the Agreement at the moment these are supplied or the order is completed by THN, delivered to the Buyer, or at the moment these are made available to the Buyer pursuant to the Agreement;
5.2 If the Buyer refuses to accept or fails to provide information or instructions required for supply or completion, THN has the right to store the goods at the expense and risk of the Buyer;
5.3 If THN requires information from the Buyer with regard to the execution of the Agreement, the supply or completion term will only commence once this has been provided to THN by the Buyer;
5.4 If THN has set a time scale for supply or completion, it is only indicative. Any supply or completion time scale indicated shall in no case be considered binding. If any such time scale is exceeded, the Buyer must give written notice of default to THN;
5.5 THN has the right to supply or complete work partially, unless the Agreement states otherwise or where partial supply or completion is of no independent value. THN has the right to invoice separately for partial supply or completion.

Article 6 Inspection and defects

6.1 The Buyer must inspect the supplied goods or services at the moment of supply or completion. In doing so, the Buyer should inspect whether the quality and quantity of the goods or services supplied or completed comply with what has been agreed, or with the requirements expected in normal (trading) transactions;
6.2 THN should be notified in writing of any visible defects within 8 days of supply or completion. Invisible defects should be reported in writing within 8 days of discovery but no later than 3 months after supply or completion;
6.3 THN must be allowed to inspect any reported defects;
6.4 If timely notice of defects was given and the defects have been verified by THN, THN will repair the defects or shortcomings within a reasonable time scale, or replace the goods or services that have been supplied or completed. Nonetheless, the Buyer will remain obliged to pay for work carried out and goods delivered;
6.5 If timely notice of any defect was not given or if the Buyer has put to use the goods or services supplied or completed, these will be deemed to have been supplied or completed satisfactorily;
6.6 If the Buyer wishes to return defective goods, this may only be done with the prior written permission of THN and in the manner indicated by THN.

Article 7 Compensation, price and costs

7.1 THN has the right to demand a deposit amount of 10 to 50% of the agreed price before work is commenced;
7.2 If THN has agreed a fixed price with the Buyer, THN reserves the right to increase that price in the cases stated below;
7.3 THN has the right to pass on to the Buyer changes in costs relating to social contributions, turnover taxes, exchange rates, wages, raw materials, semi-products, packaging materials or other costs occurring after the Agreement was made.

Article 8 Changes to the Agreement

8.1 If during the execution of the Agreement it becomes apparent that in order to deliver satisfactory results it is necessary to change or supplement the work being carried out, the parties should amend the Agreement to that effect in a timely and mutually agreed manner;
8.2 If the parties change and/or supplement the Agreement, the time of completion may be affected. THN will notify the Buyer of this as soon as possible;
8.3 If changes and/or additions to the Agreement have financial and/or qualitative consequences, THN will notify the Buyer of this in advance;

Article 9 Payment

9.1 Payment must be made either in cash upon supply or completion, or within 30 days of the date of the invoice, in the manner indicated by THN and in the currency on the invoice. Disagreements about the amount of an invoice do not defer the Buyer's obligation to pay;
9.2 If the Buyer fails to pay within the 30-day term, he or she is considered to be in default in the eyes of the law. The Buyer shall then owe interest of 1% per month or part thereof, unless the statutory interest or the statutory commercial interest (after 30 days) is higher, in which case the higher interest applies. The interest on the outstanding amount will be calculated from the moment the Buyer enters default until the moment the full amount has been received;
9.3 If the Buyer enters into liquidation, petitions for or enters into bankruptcy, requests or is granted debt rescheduling under the Dutch Natural Persons Debt Rescheduling Act, is repossessed or is granted (temporary) suspension of payment, the outstanding sums the Buyer owes THN will become due immediately;

Article 10 Retention of title

10.1 All materials and other goods delivered by THN will remain the property of THN until the Buyer has met all obligations towards THN;
10.2 The Buyer has no authority to sell, provide as security or otherwise encumber goods falling under retention of title rights;
10.3 With immediate effect, the Buyer gives unconditional and irrevocable permission for THN or any third parties it appoints to enter any premises that contain THN's property and to repossess these goods, should THN wish to exercise its retention of title rights as defined in this article.

Article 11 Transfer of risk

11.1 The risk of loss of or damage to goods produced by THN will be transferred to the Buyer from the moment these goods are legally or actually supplied or the order is completed, and thus brought into the ownership of the Buyer or a third party appointed by the Buyer.

Article 12 Collection costs

12.1 If the Buyer defaults on or neglects to fulfil his obligations (in a timely manner), the Buyer will be liable for all reasonable costs incurred in extrajudicial enforcement. In any case, the Buyer must pay collection costs if a monetary demand is made. Collection costs will be calculated in accordance with the collection cost rate recommended for collection cases by the Netherlands Bar, with a minimum cost of EUR 350.
12.2 If THN has incurred higher costs, and these were necessary and reasonable, the Buyer will also be liable for these costs. Any reasonable legal and execution costs incurred will also be charged to the Buyer.

Article 13 Suspension and dissolution

13.1 In addition to the provisions of the law, THN has the authority to defer the fulfilment of its obligations or dissolve the Agreement if it becomes apparent to THN after the Agreement has been made that there are circumstances as a consequence of which THN has good reason to expect that the Buyer will not fulfil, or only partially fulfil his or her obligations, or not fulfil them in a timely manner. If there is good reason to expect that the Buyer will only partially or not satisfactorily fulfil his or her obligations, the dissolution of the Agreement is only permitted if justified by the shortcoming, or if the Buyer was asked to guarantee the fulfilment of his or her obligations at the time the Agreement was made, and this guarantee is not provided or is insufficient.
13.2 In addition, THN has the authority to dissolve or cause the Agreement to be dissolved if circumstances are such that fulfilment of the Agreement is impossible or can reasonably and fairly be deemed to no longer be possible, or if other circumstances mean that fulfilment of the Agreement in its present form cannot reasonably be expected, without THN becoming liable for damages to the Buyer;
13.3 If the Agreement is dissolved, any sums owed to THN by the Buyer will become due immediately. If THN defers the fulfilment of its obligations, it will retain its rights under the law and the Agreement;
13.4 THN reserves the right to demand damage compensation in any case.

Article 14 Liability

14.1 If THN should incur any liability, it will be limited in accordance with the provisions of this article.
14.2 THN can only be held liable for wilful damage or damage resulting from neglect by THN or its subordinates.
14.3 If THN is held liable, liability will be limited to the maximum compensation amount due to be paid by THN's insurer, and liability shall not exceed the invoice amount for the (partial) work concerned.
14.4 THN will not in any case be held liable for damage caused by advice it provides. Any advice will be given based on the facts and circumstances known to THN and in mutual discussion with the Buyer, in which THN will take the Buyer's intentions as a guide and starting point.
14.5 THN will never be held liable for indirect damage, being consequential damage, lost profit, missed savings and damage from business stagnation.
14.6 THN must be notified immediately and in writing of any damage claims and in any case no later than within five working days of the damage occurring.

Article 15 Force majeure

15.1 THN is not bound to the fulfilment of any obligation if it is impeded from doing so by circumstances not caused wilfully or through neglect by THN and not attributable to THN either in the eyes of the law, through a legal exchange or by general accepted industry opinion;
15.2 In addition to the provisions of the law and the courts, in these general terms and conditions force majeure includes any expected or unexpected external causes which THN cannot influence, and which cause THN to be unable to fulfil its obligations. This includes labour strikes at THN, staff illness, theft, traffic delays, frost, rain and failure of suppliers to deliver materials;
15.3 THN also has the right to seek recourse to force majeure if the circumstances that impede (further) fulfilment occur after THN should have fulfilled its obligation;
15.4 THN can defer its obligations for the duration of the force majeure circumstances. If this period is longer than two months, THN has the right to dissolve the Agreement without incurring liability for damages to the Buyer;
15.5 If THN has partially fulfilled or will be able to partially fulfil its obligations under the Agreement at the time of the force majeure circumstances and the fulfilled part or part to be fulfilled respectively is deemed to have independent value, THN has the right to invoice separately for the fulfilled part or part to be fulfilled respectively. The Buyer must pay this invoice as if it were a separate Agreement.

Article 16 Disputes

16.1 The court of law in THN's locality has the exclusive jurisdiction to settle any disputes.

Article 17 Governing law

17.1 The laws of the Netherlands apply to any Agreement between THN and the Buyer..



THN

Hendrik ter Kuilestraat 30
7547 BD Enschede
the Netherlands

+31 (0)53 432 34 46

www.thn.nl